

Fig. 1

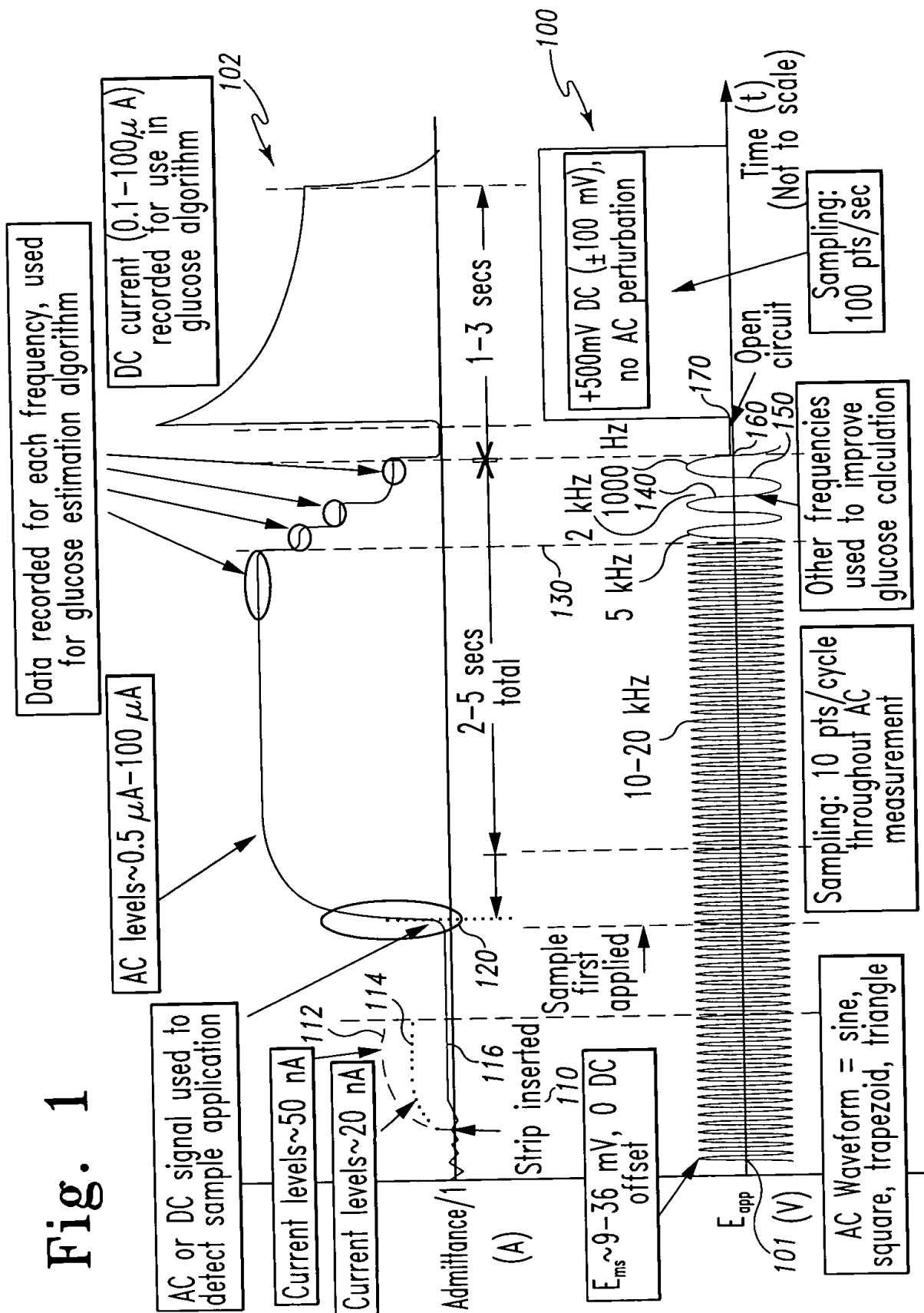
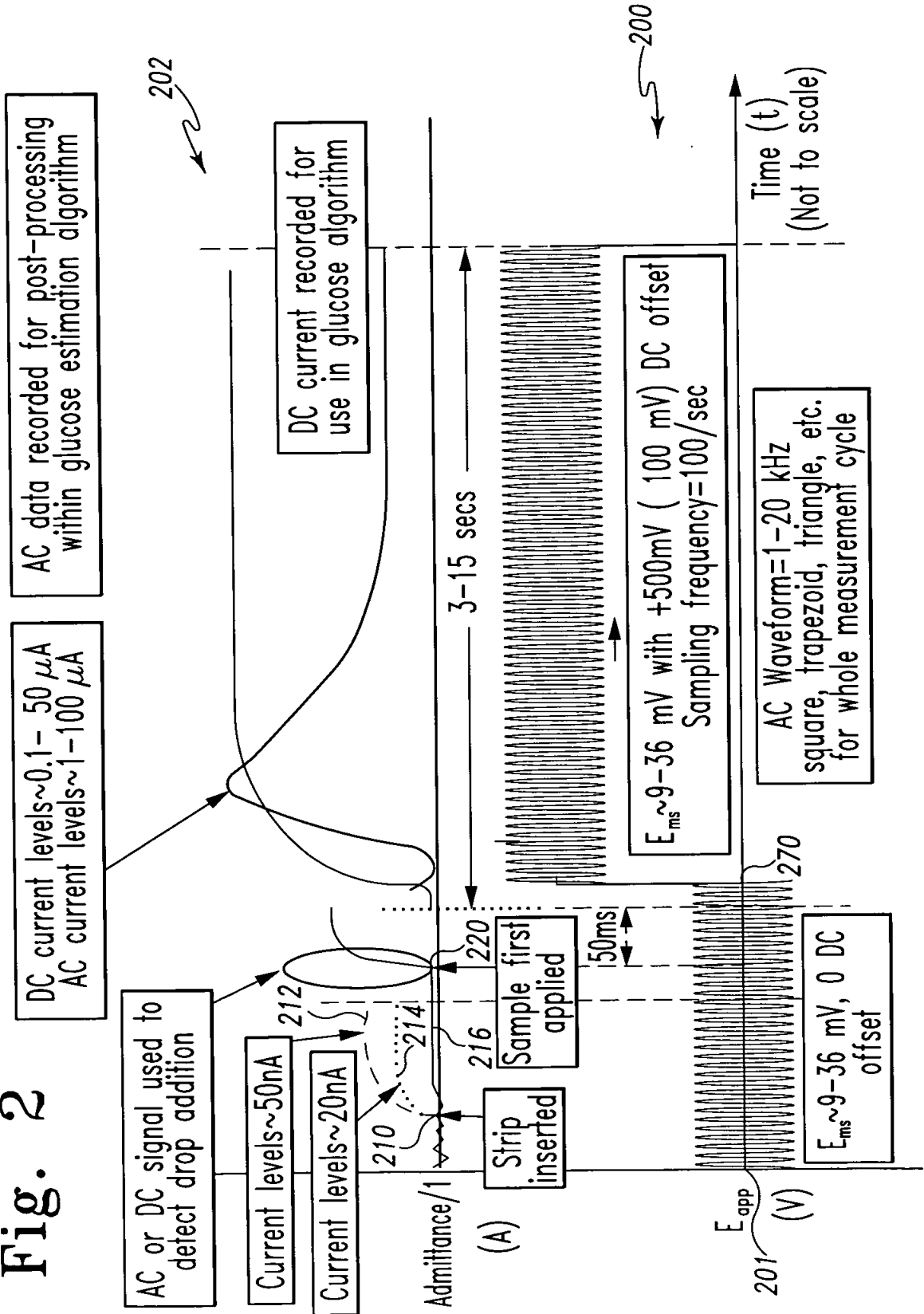

Fig. 2



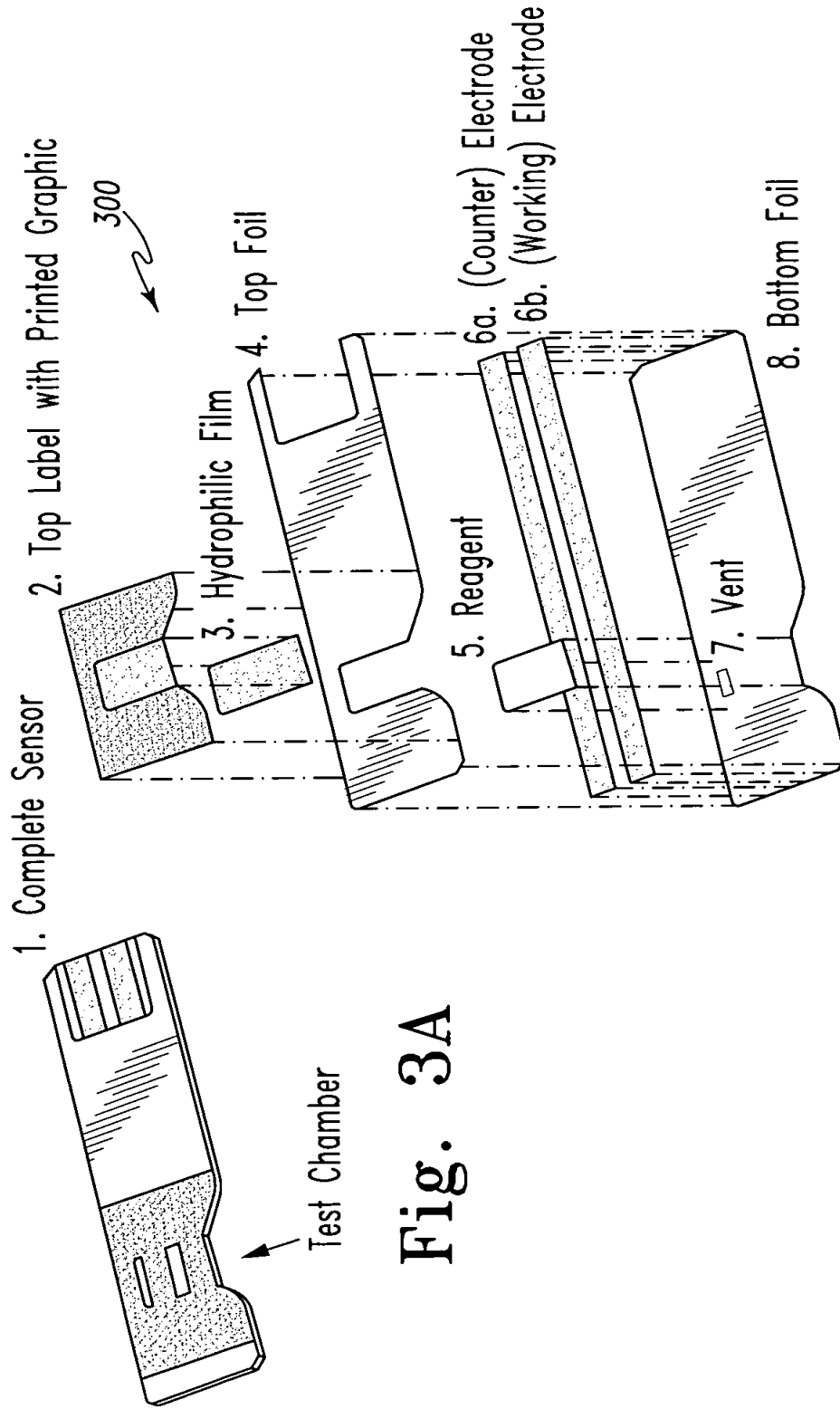

Fig. 3A

Fig. 3B

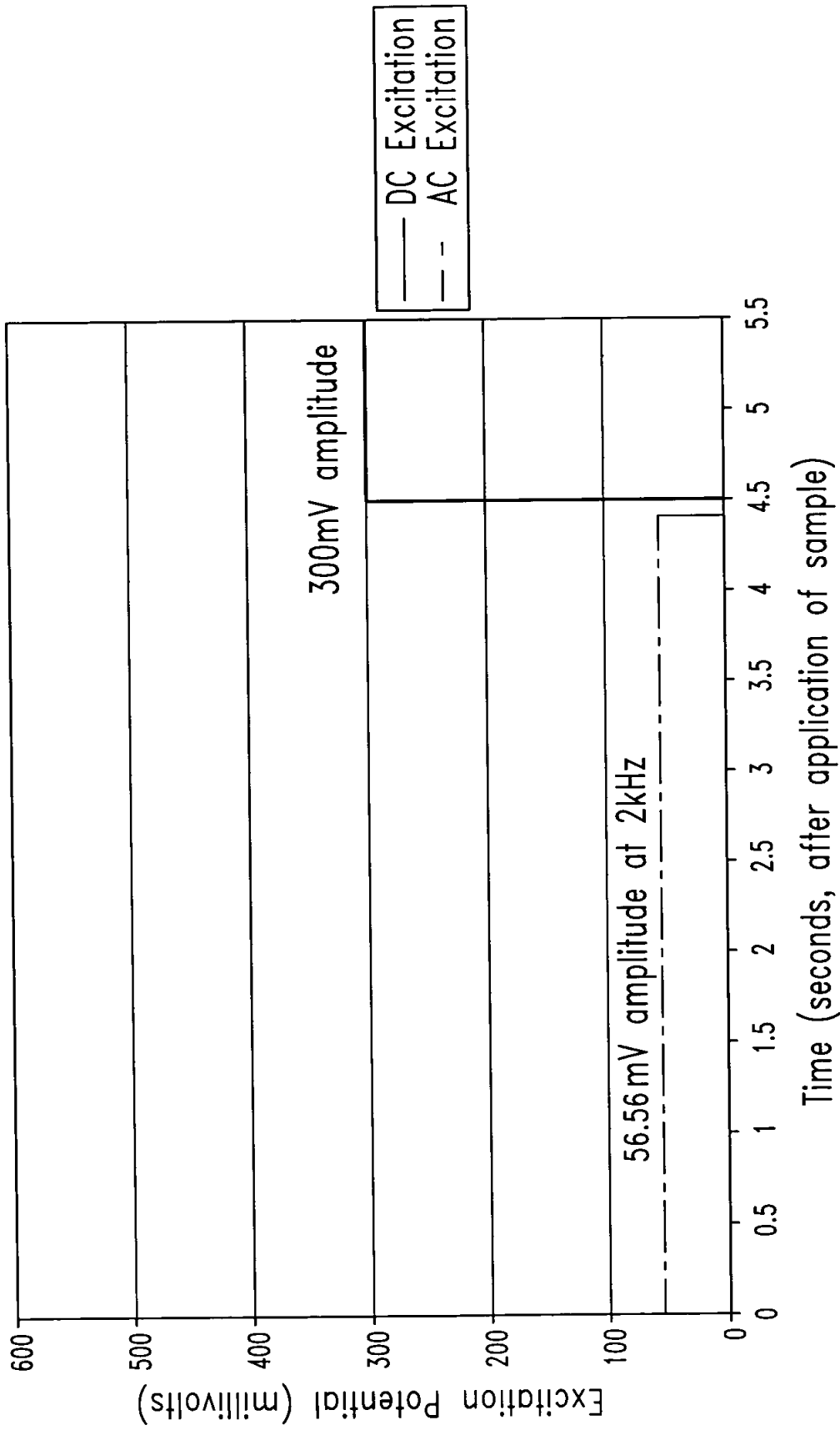

Fig. 4

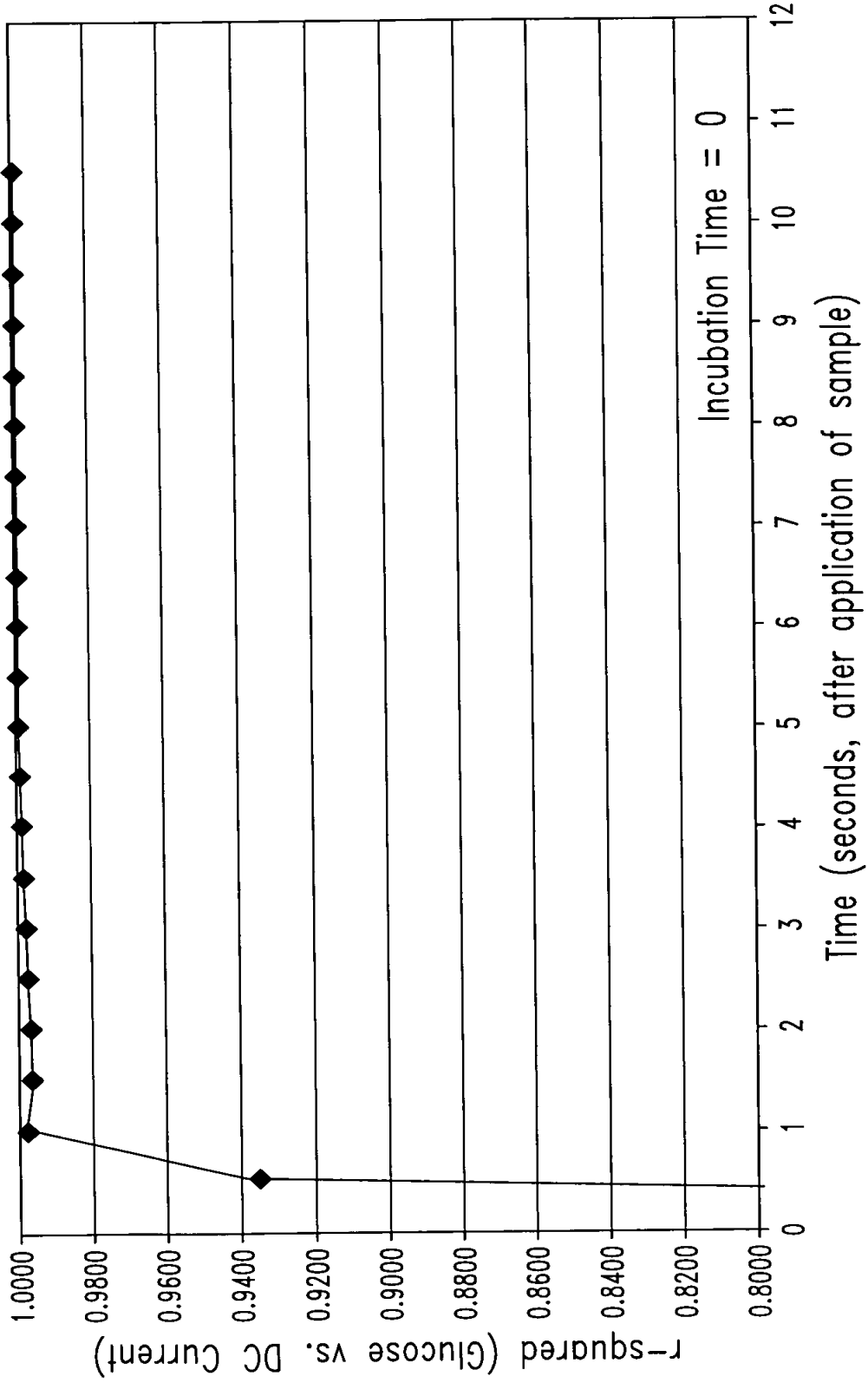

Fig. 5

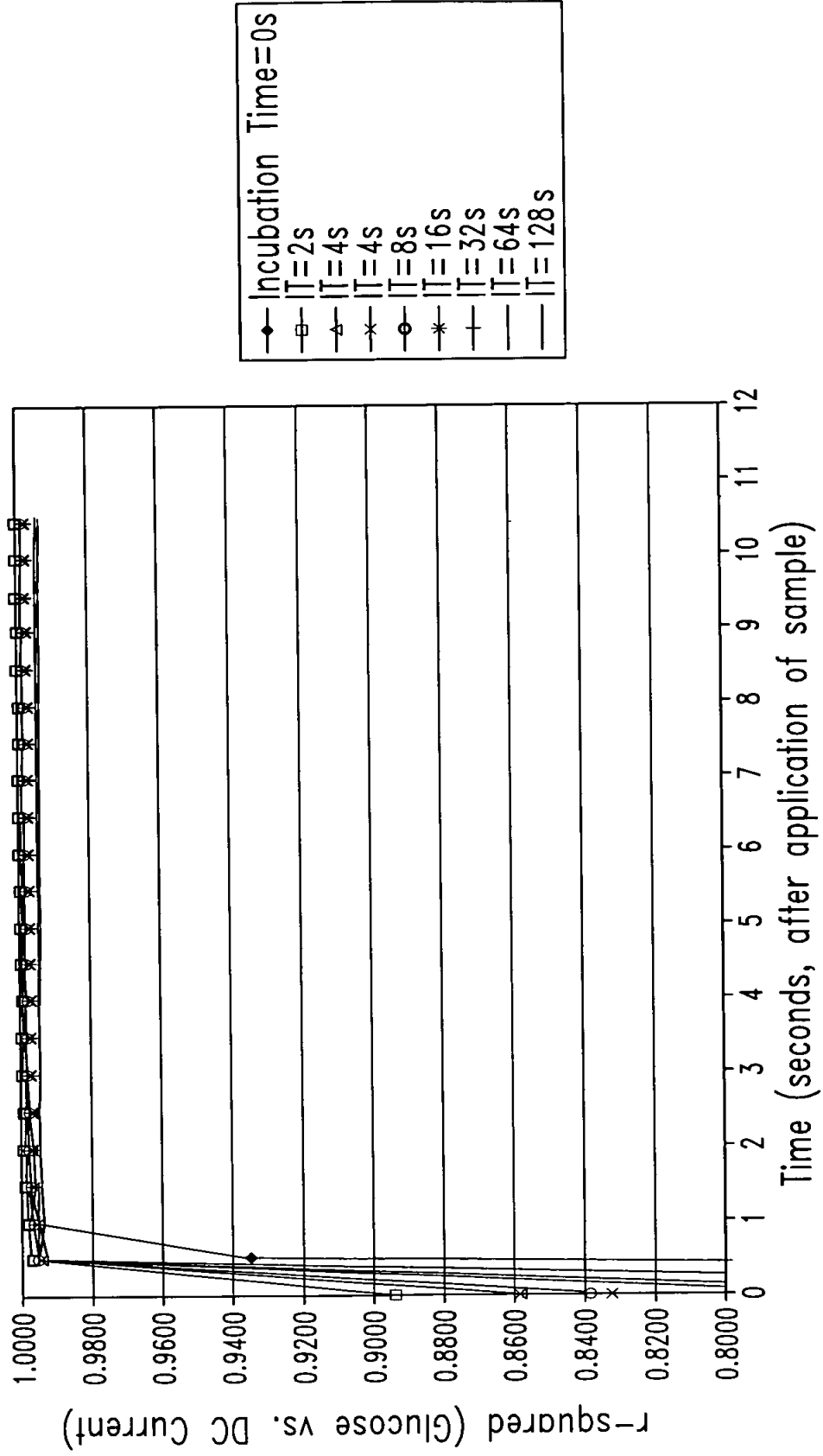

Fig. 6

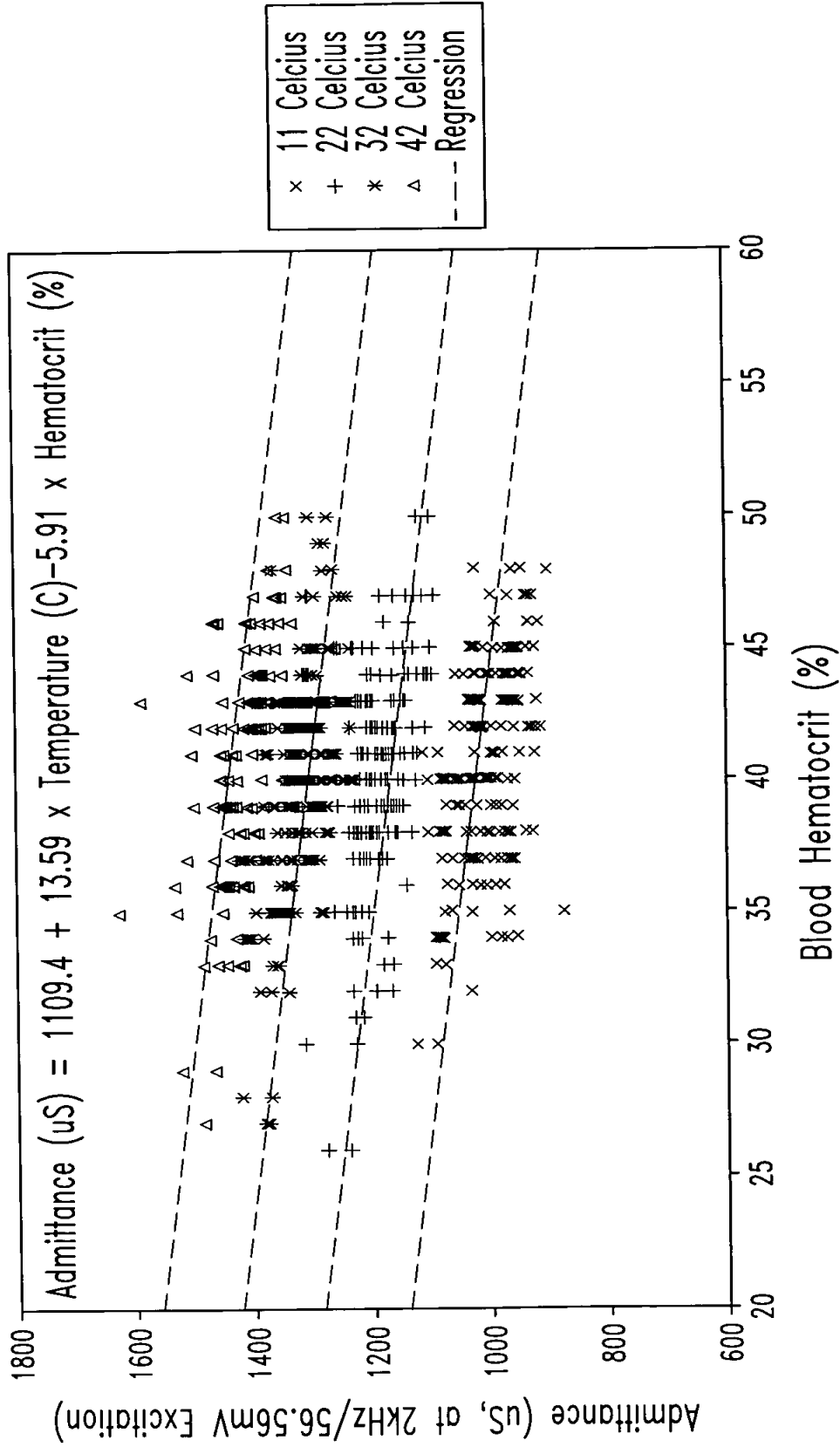

Fig. 7

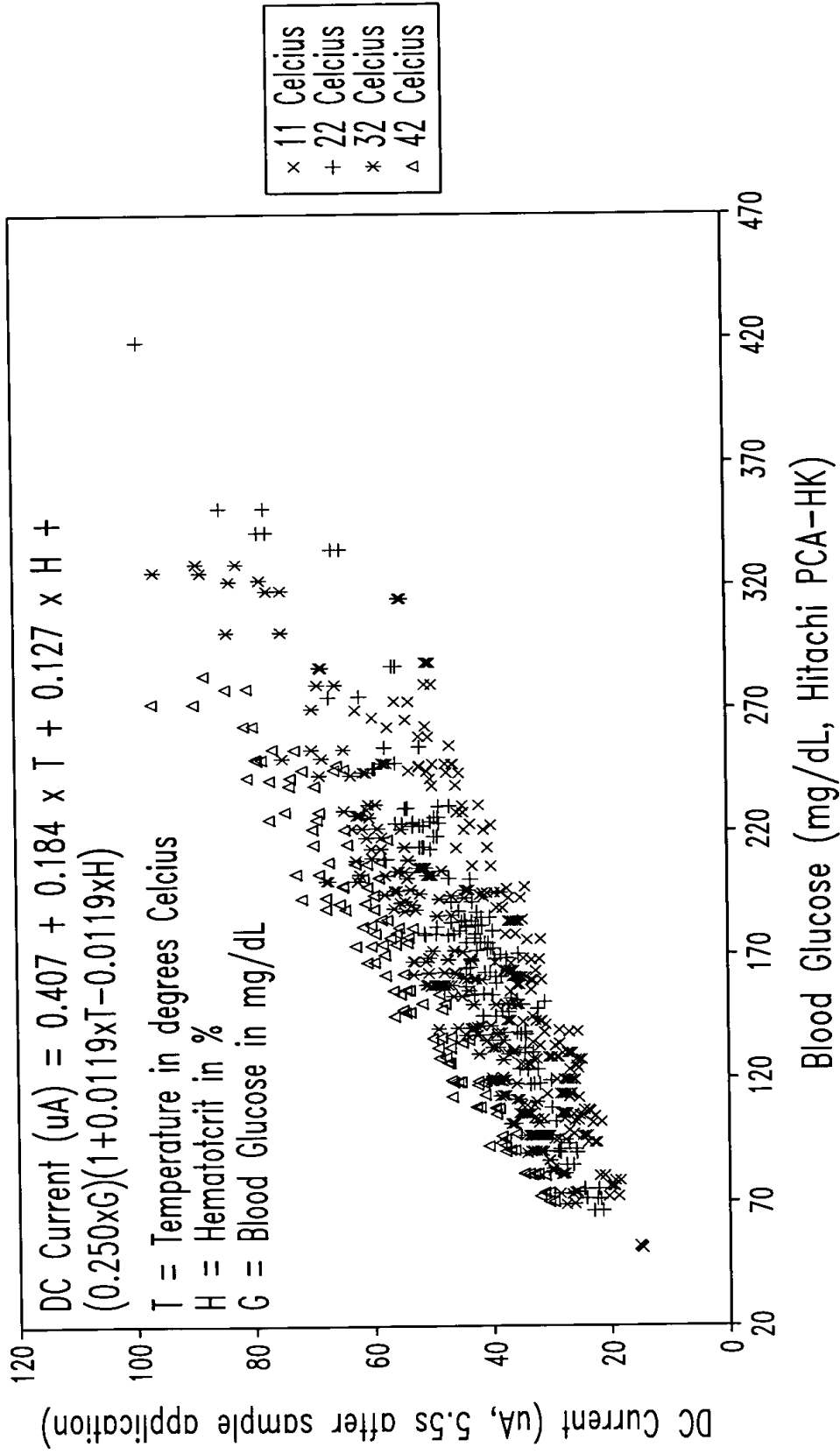

Fig. 8

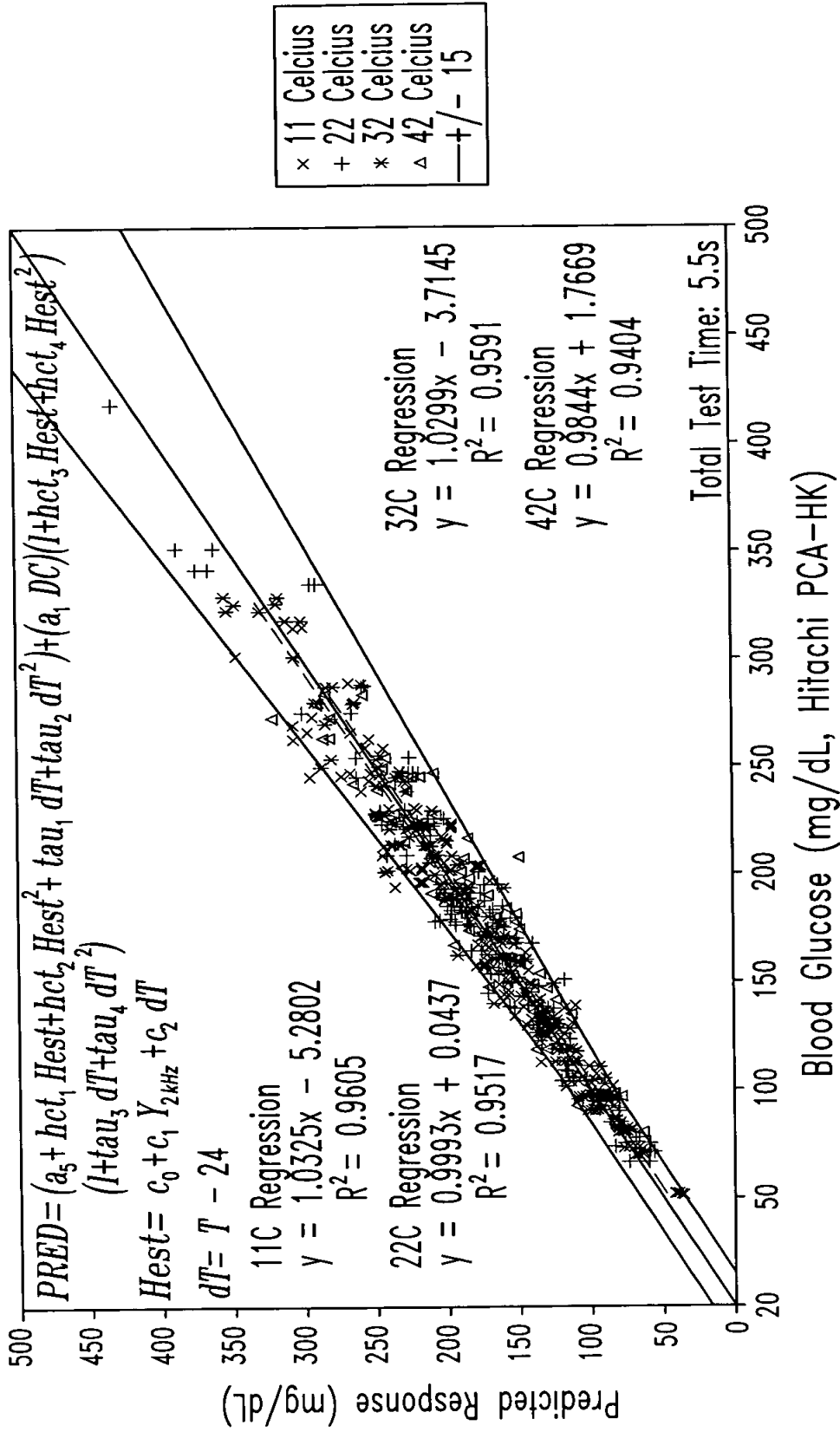

Fig. 9

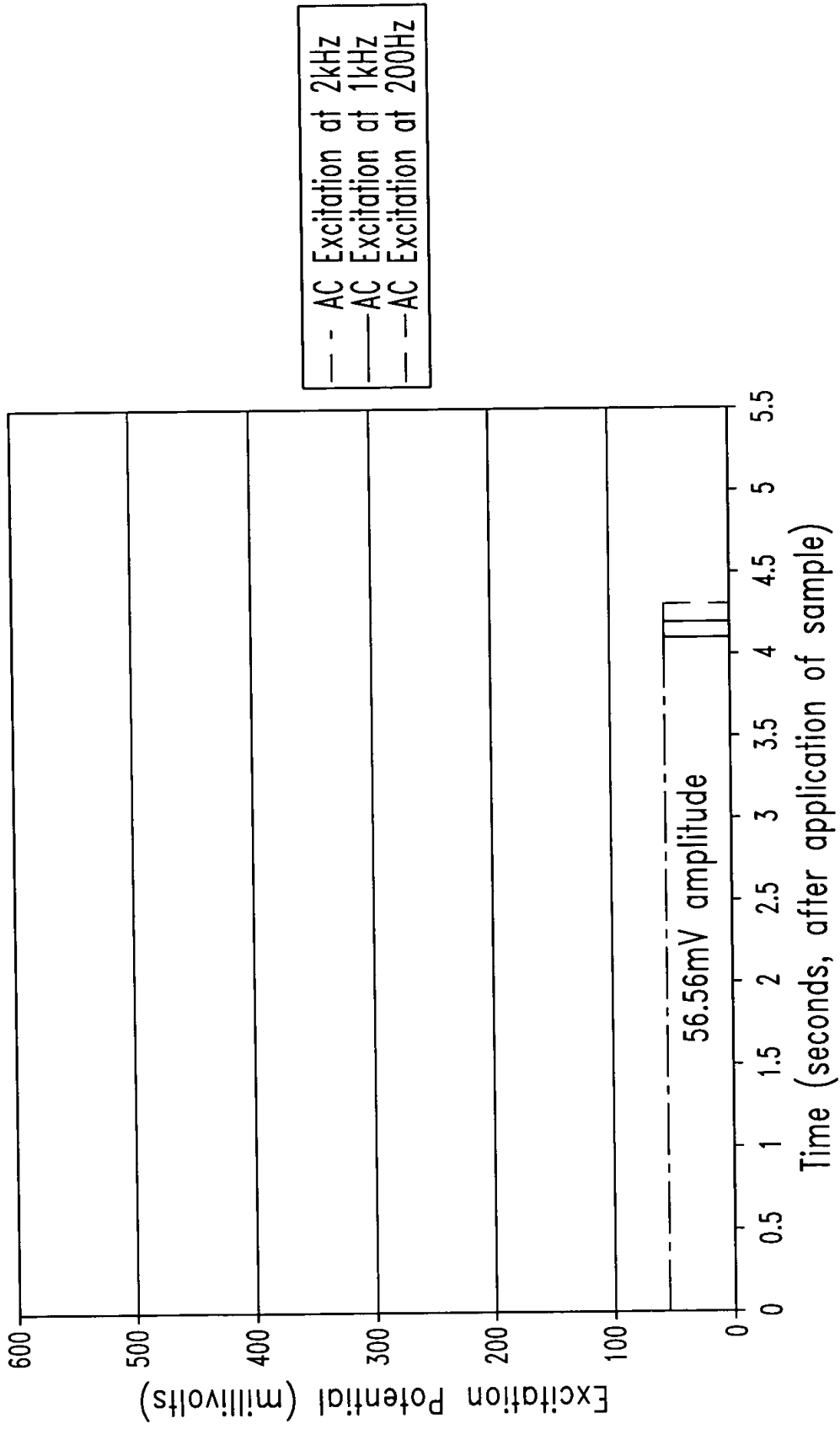

Fig. 10

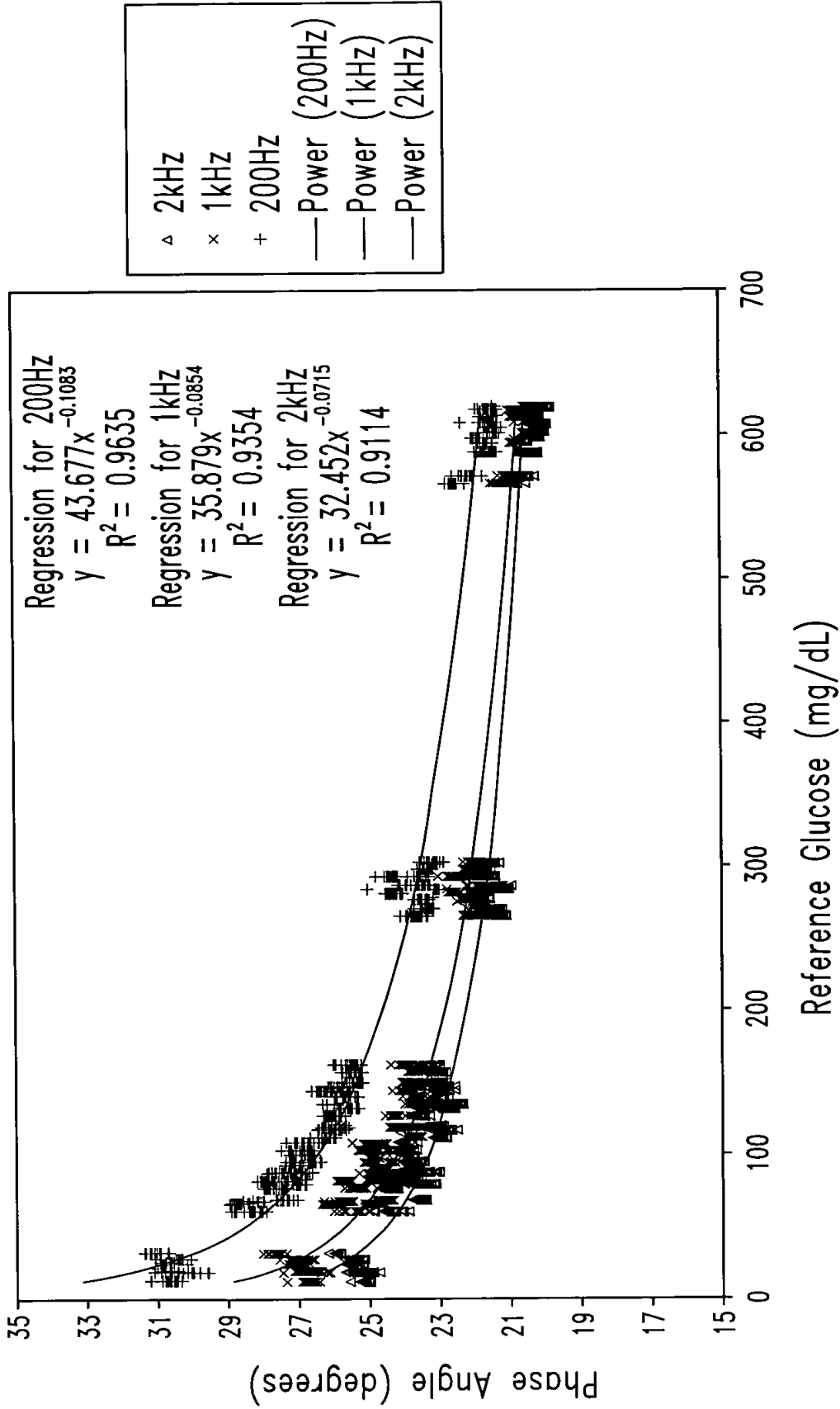

Fig. 11

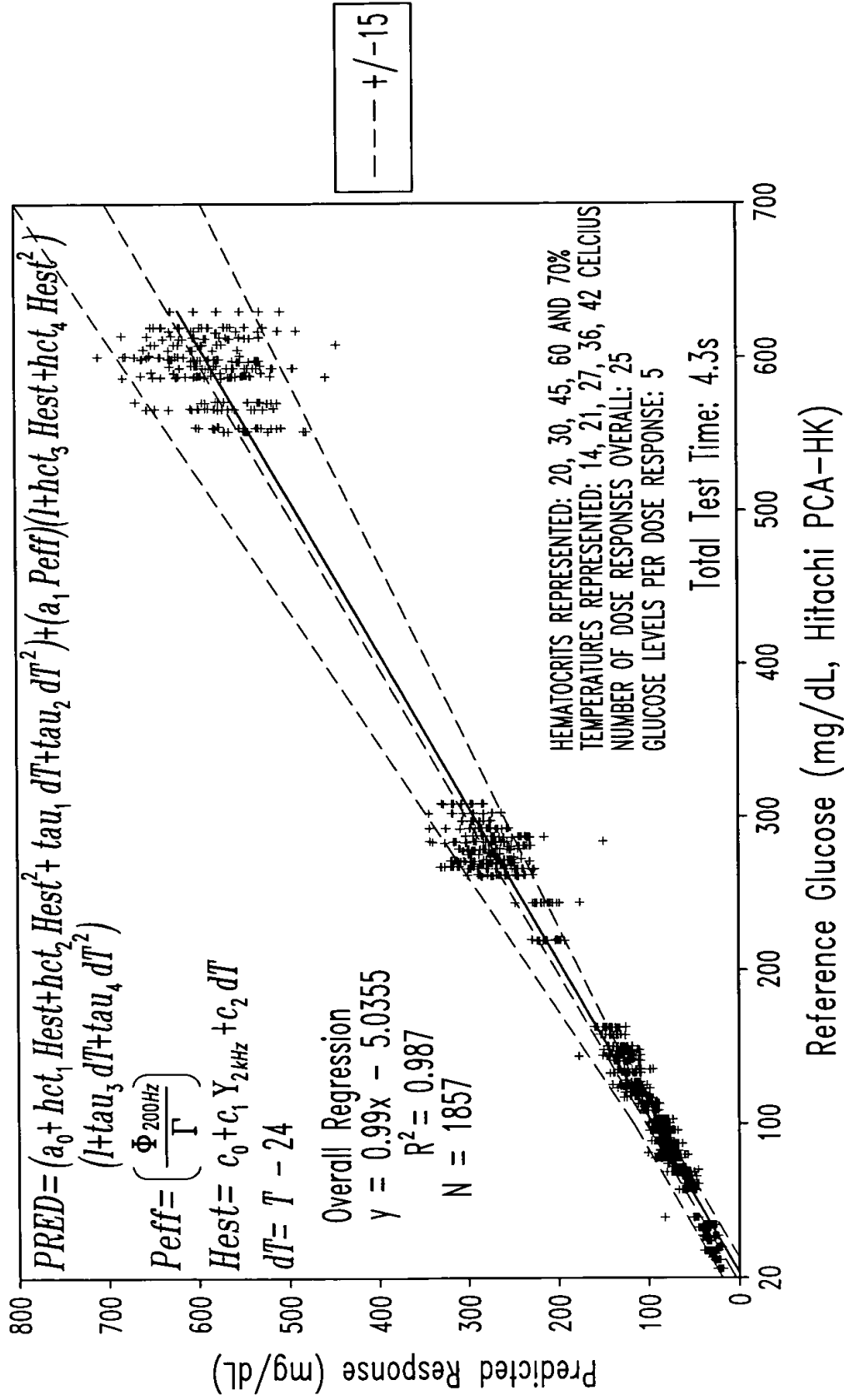

Fig. 12

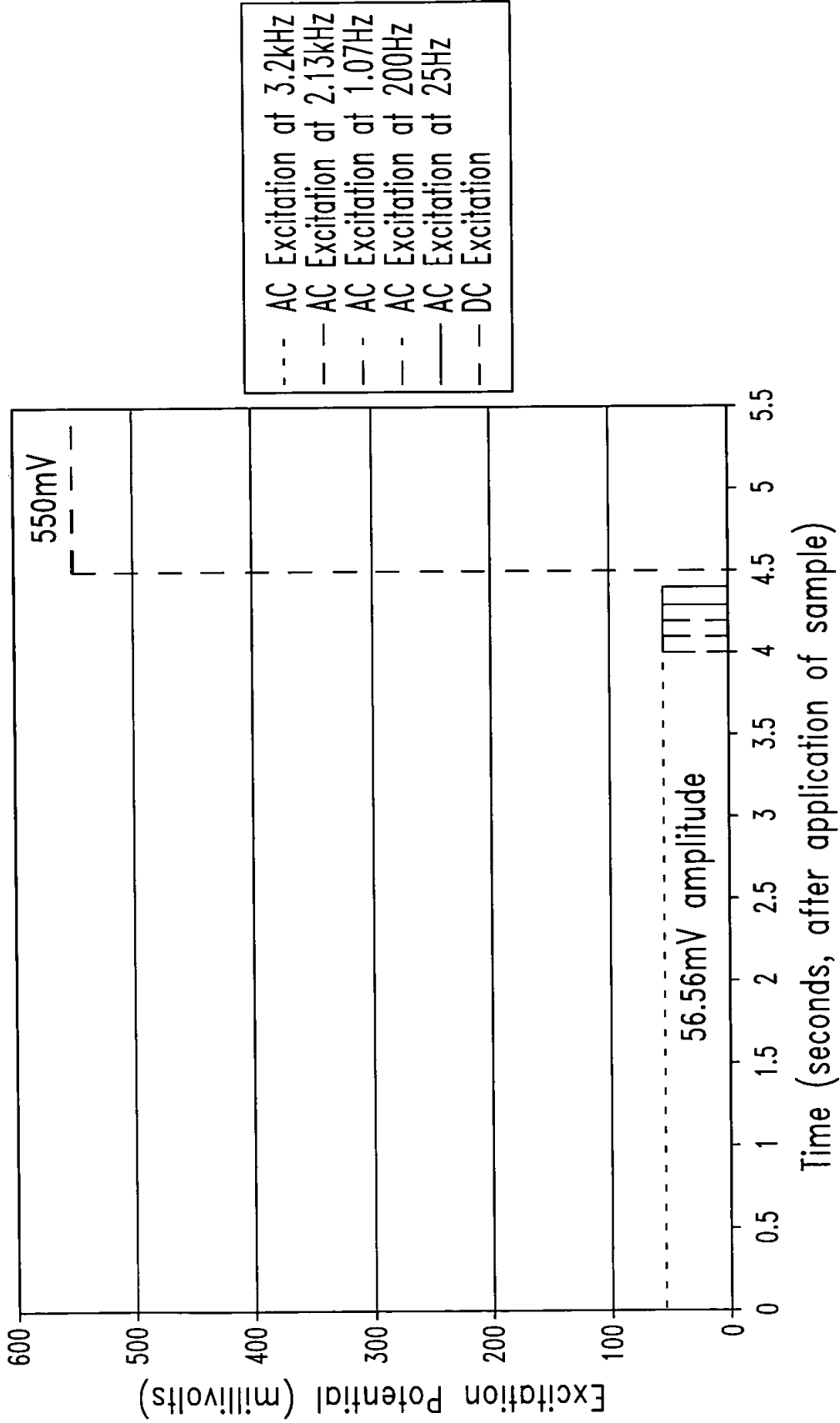

Fig. 13

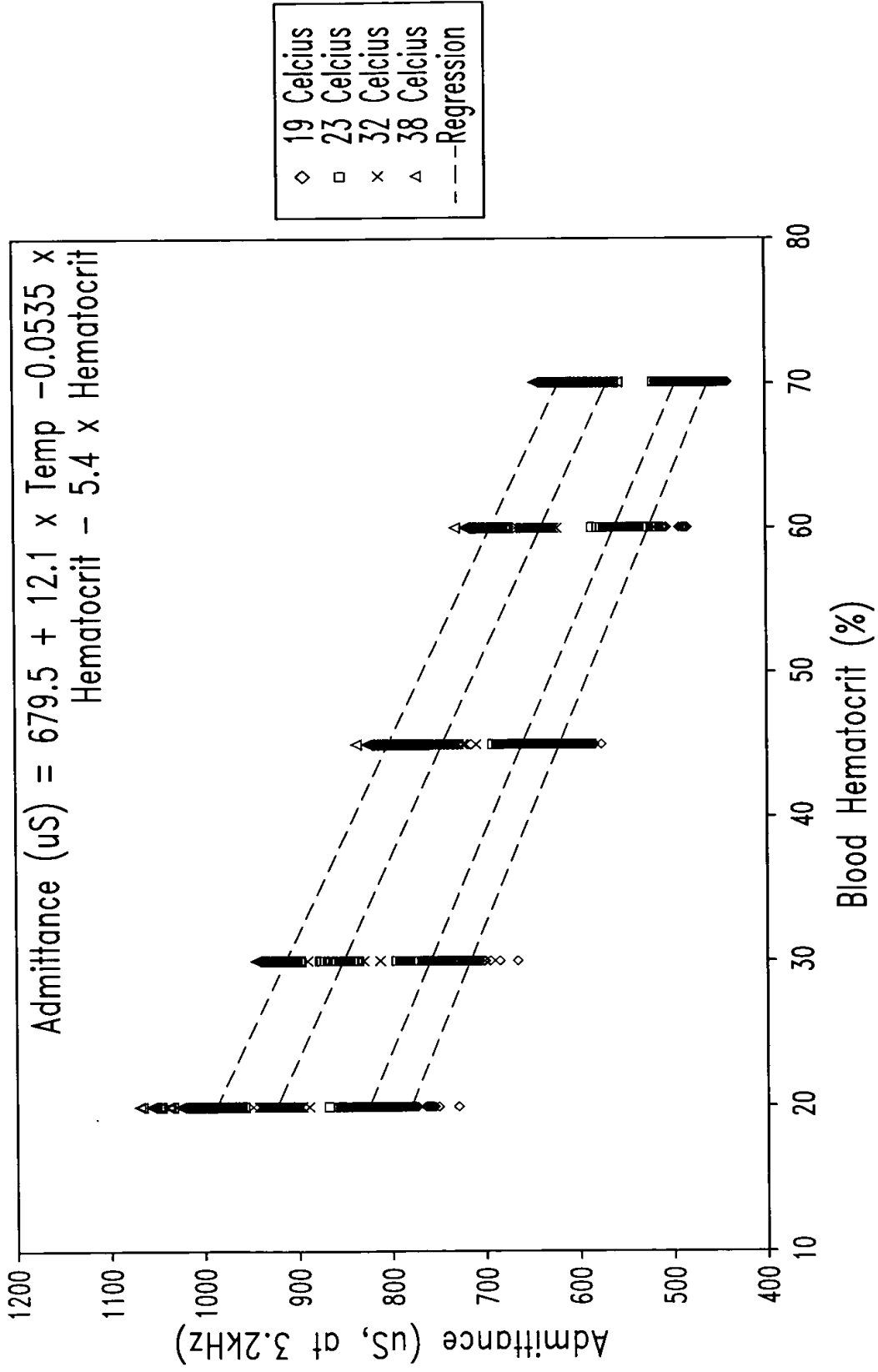

Fig. 14

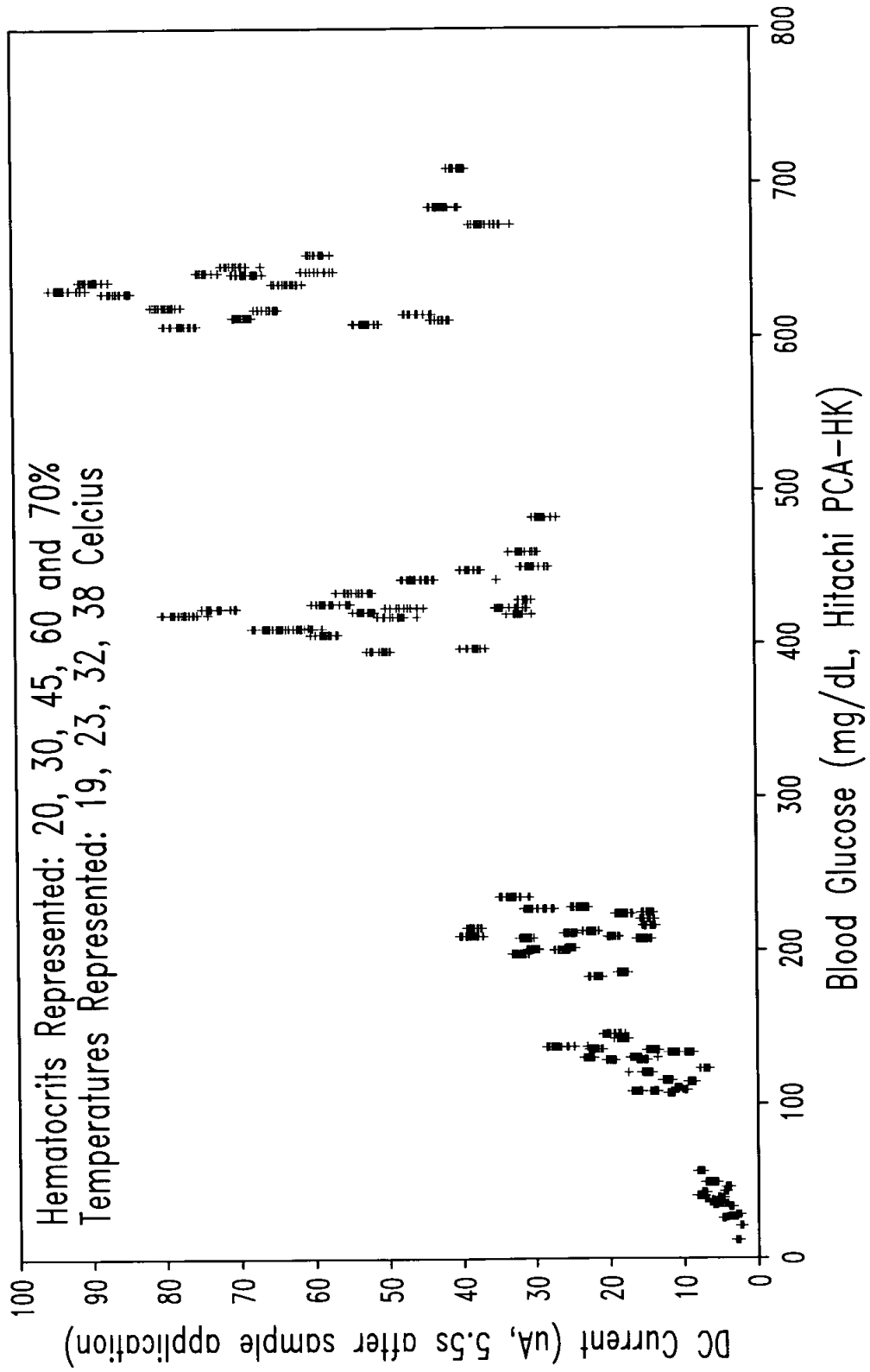

Fig. 15

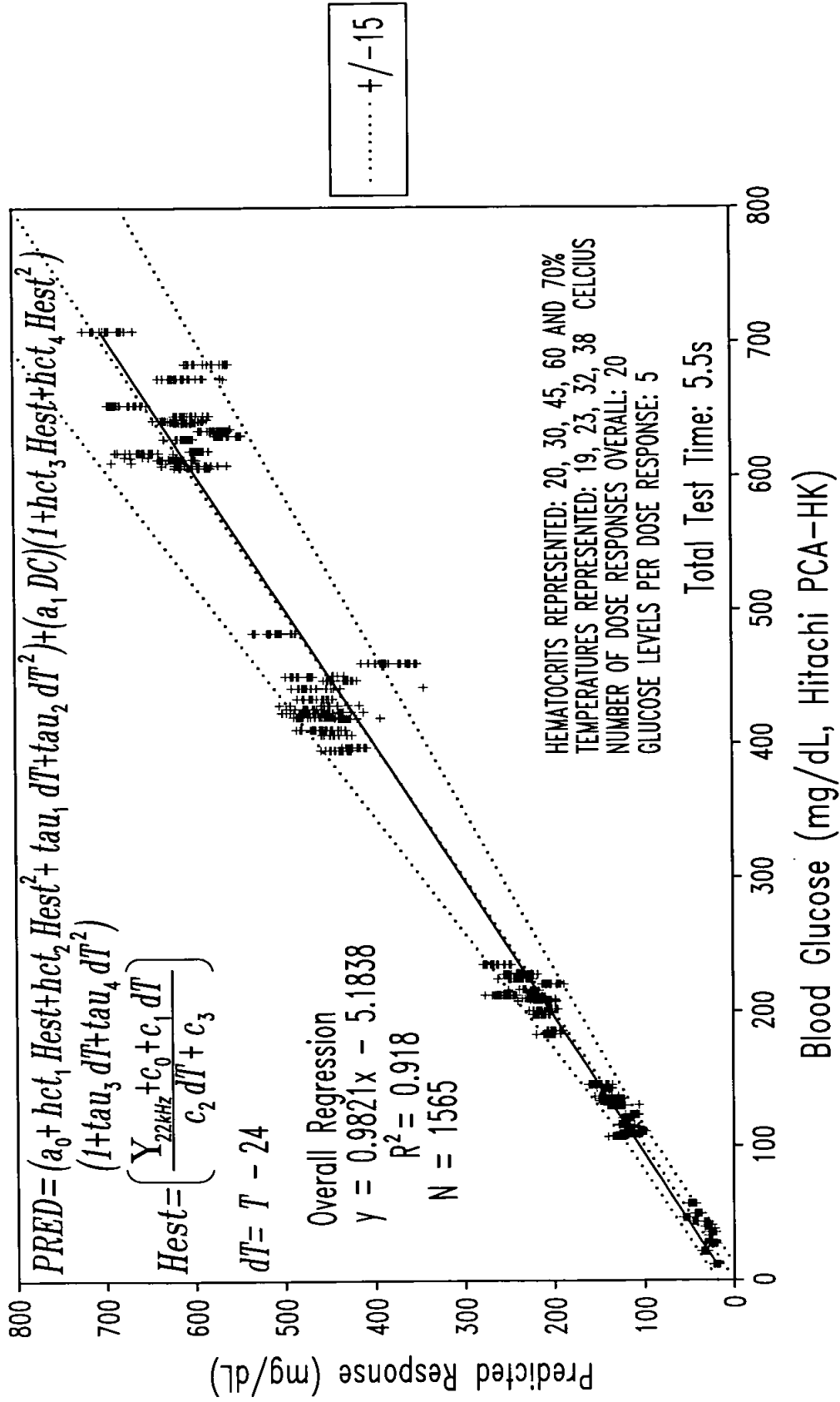

Fig. 16

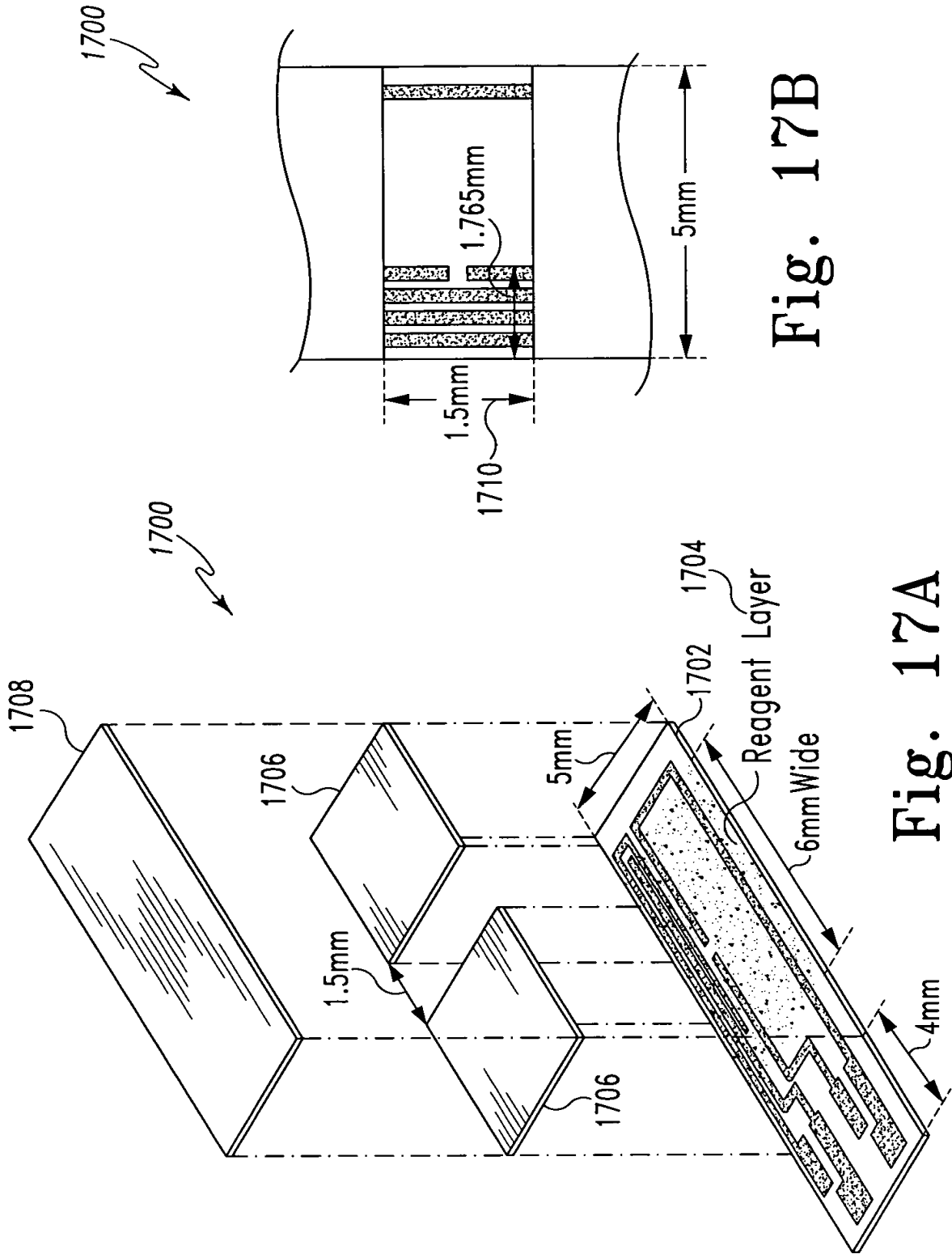

Fig. 17B

Fig. 17A

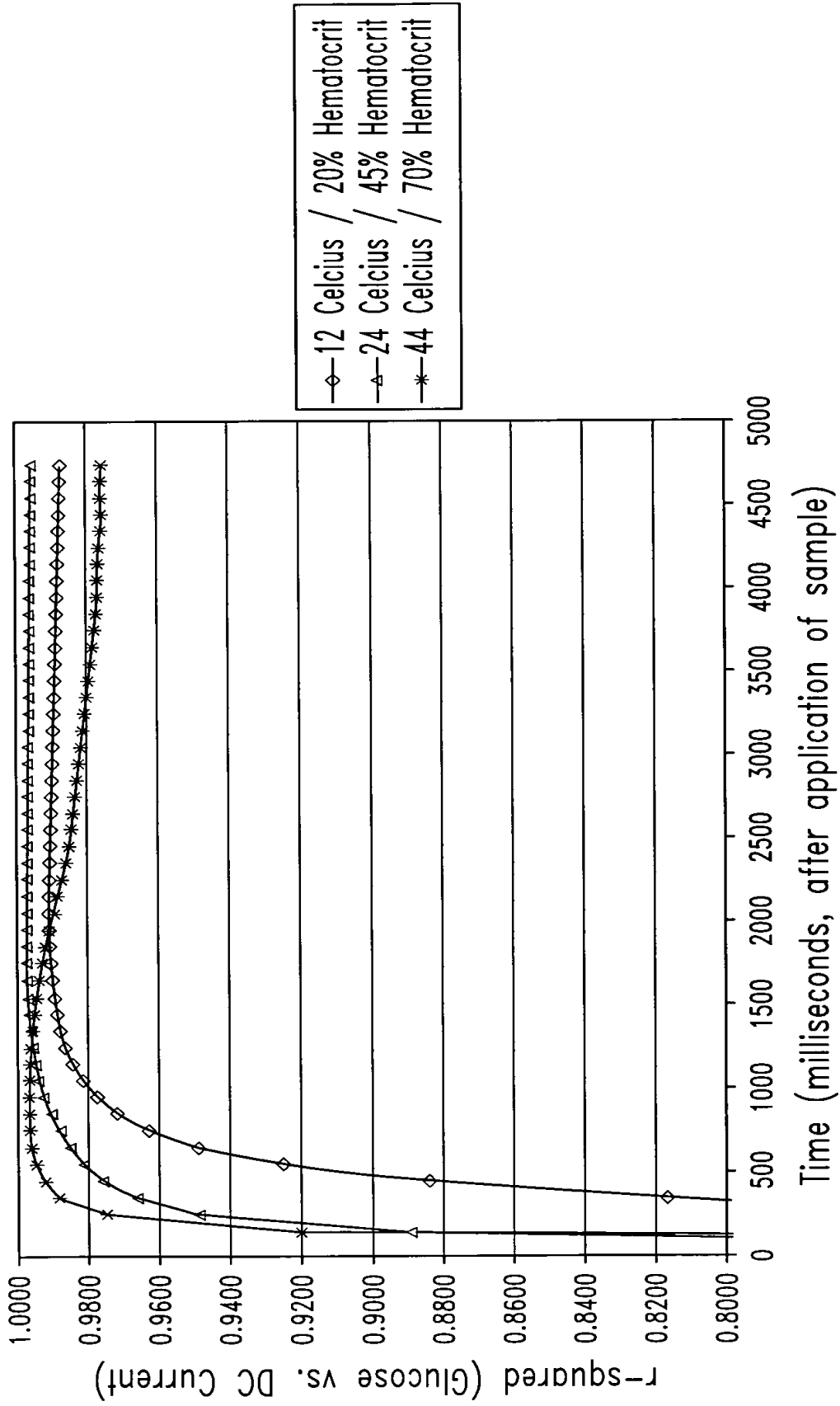

Fig. 18

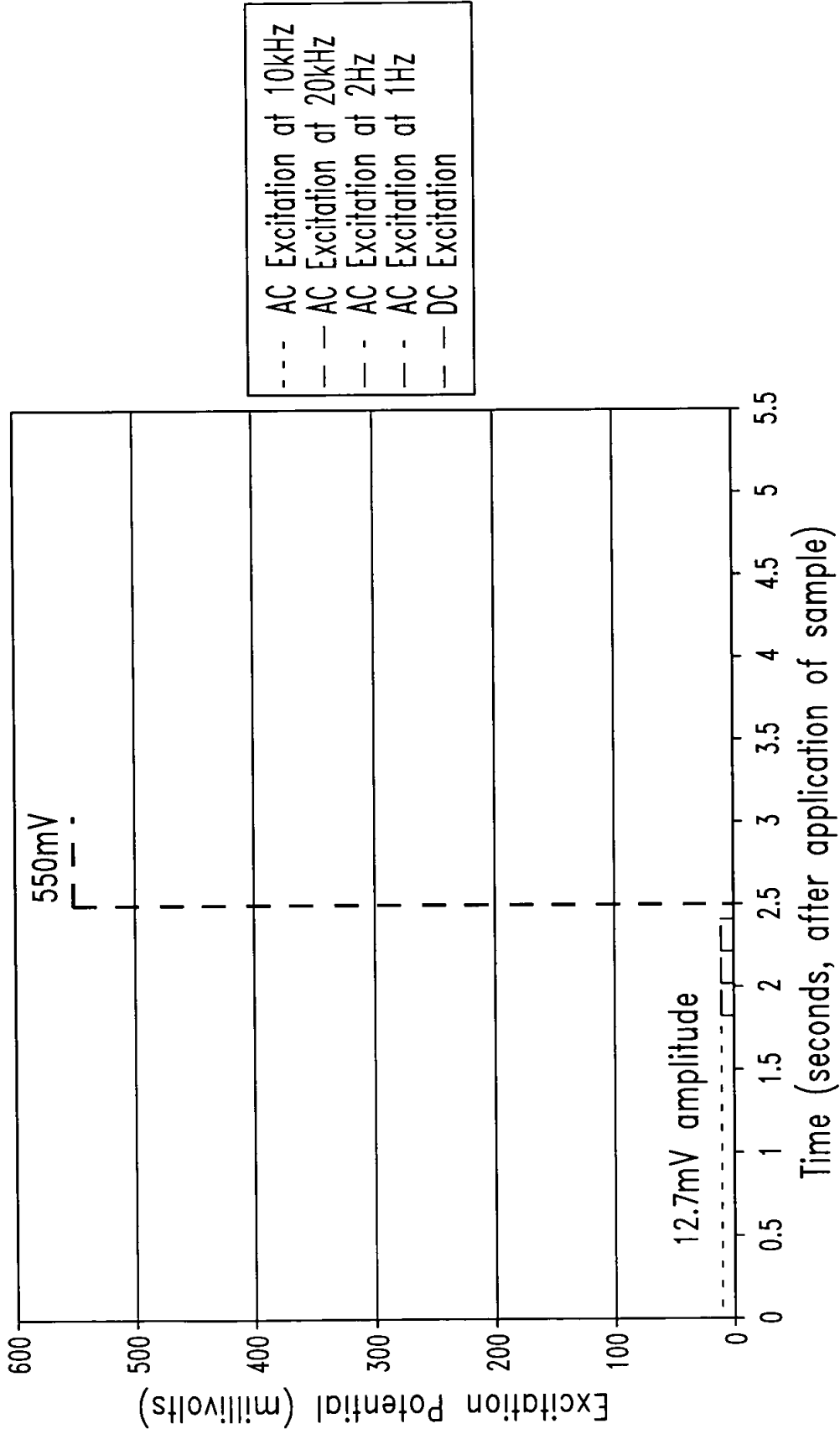

Fig. 19

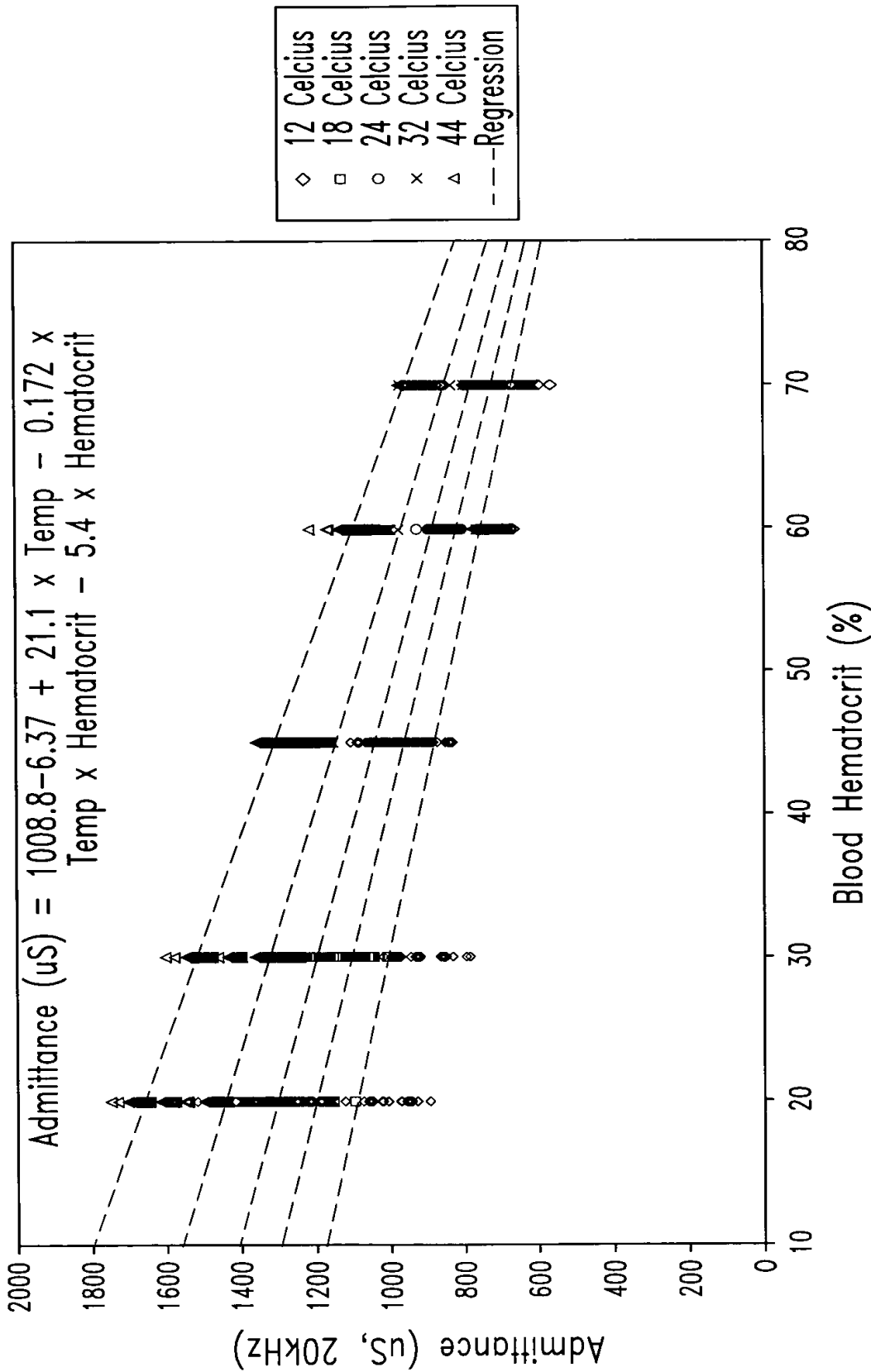

Fig. 20

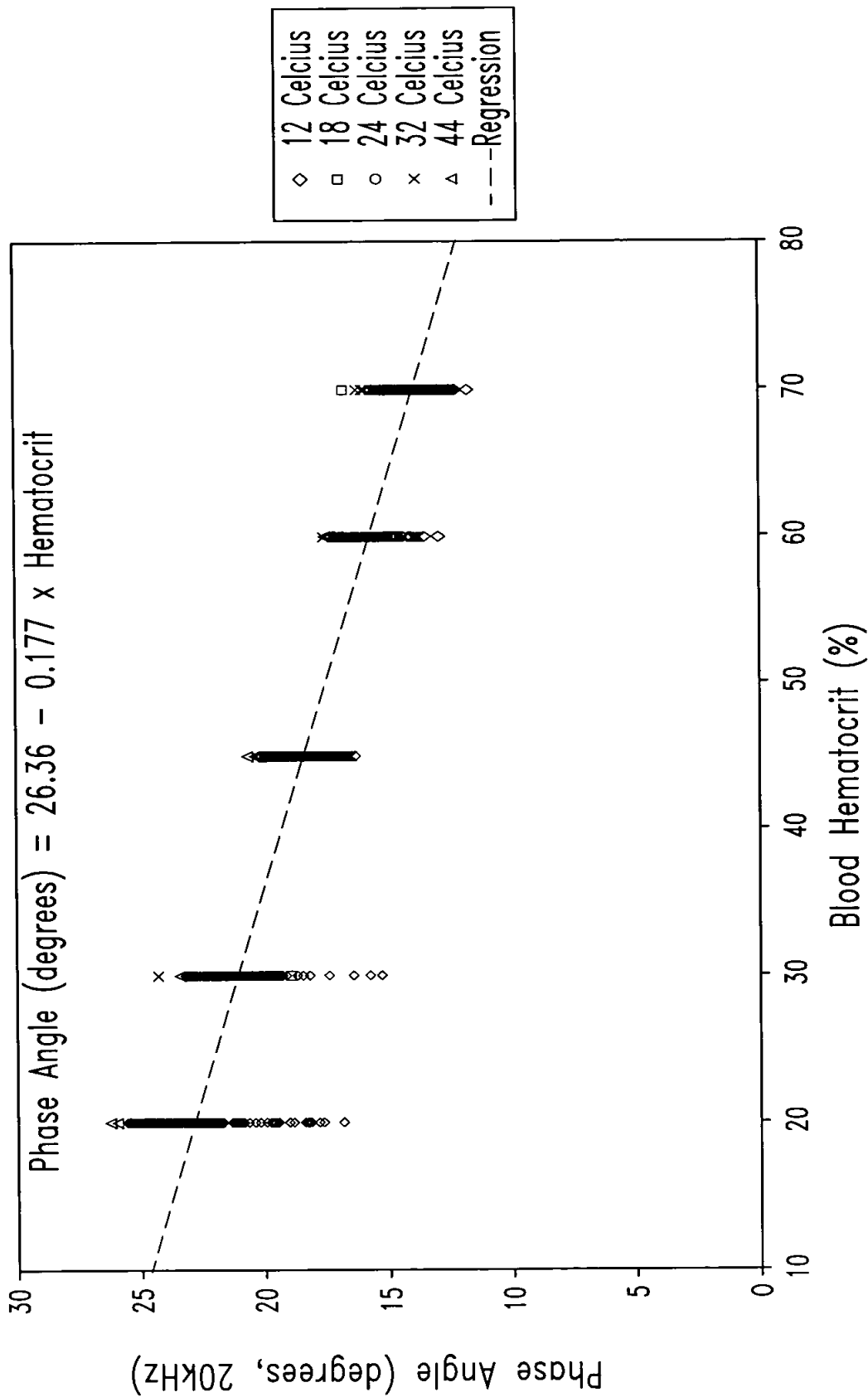

Fig. 21

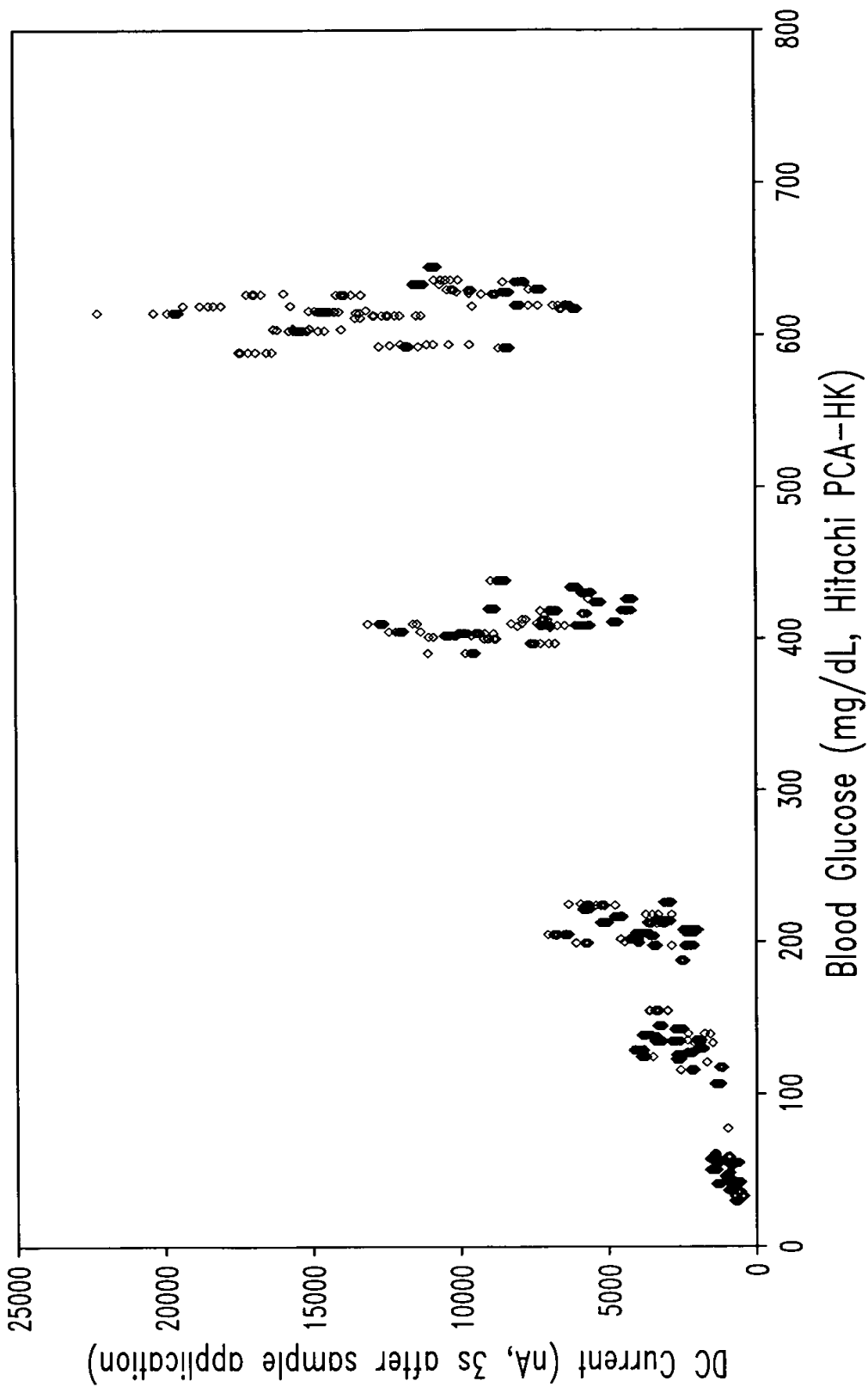

Fig. 22

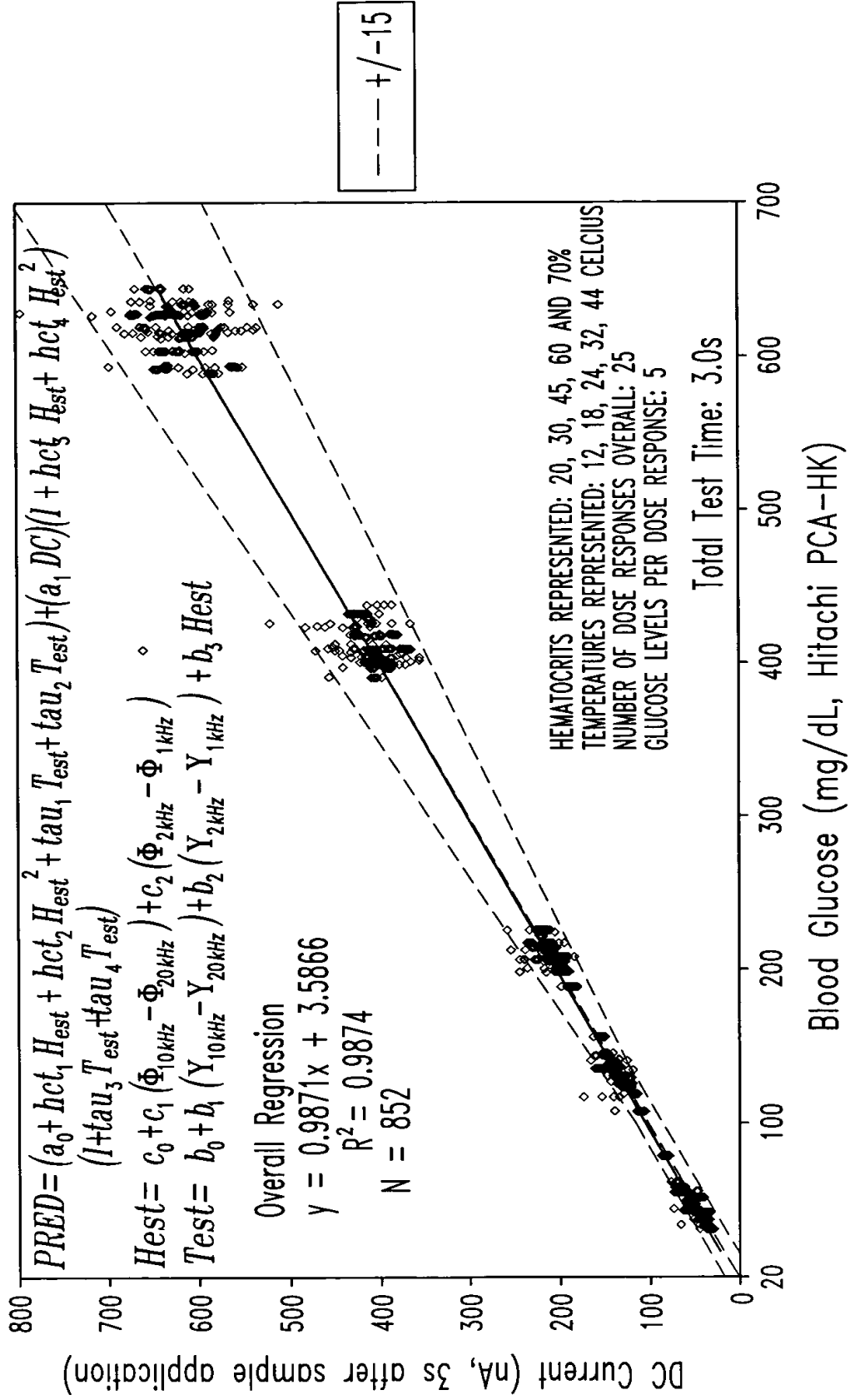

Fig. 23

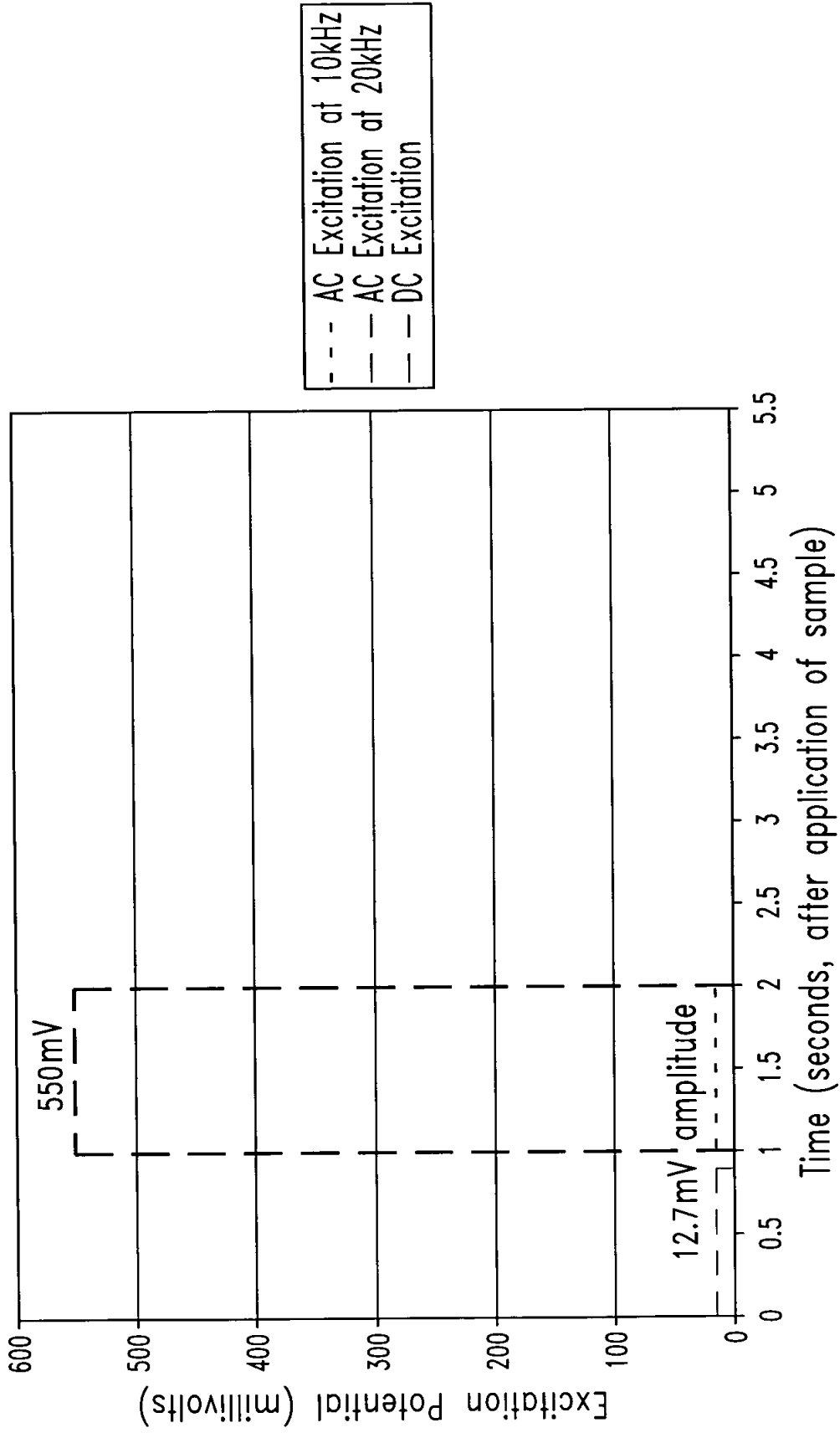

Fig. 24

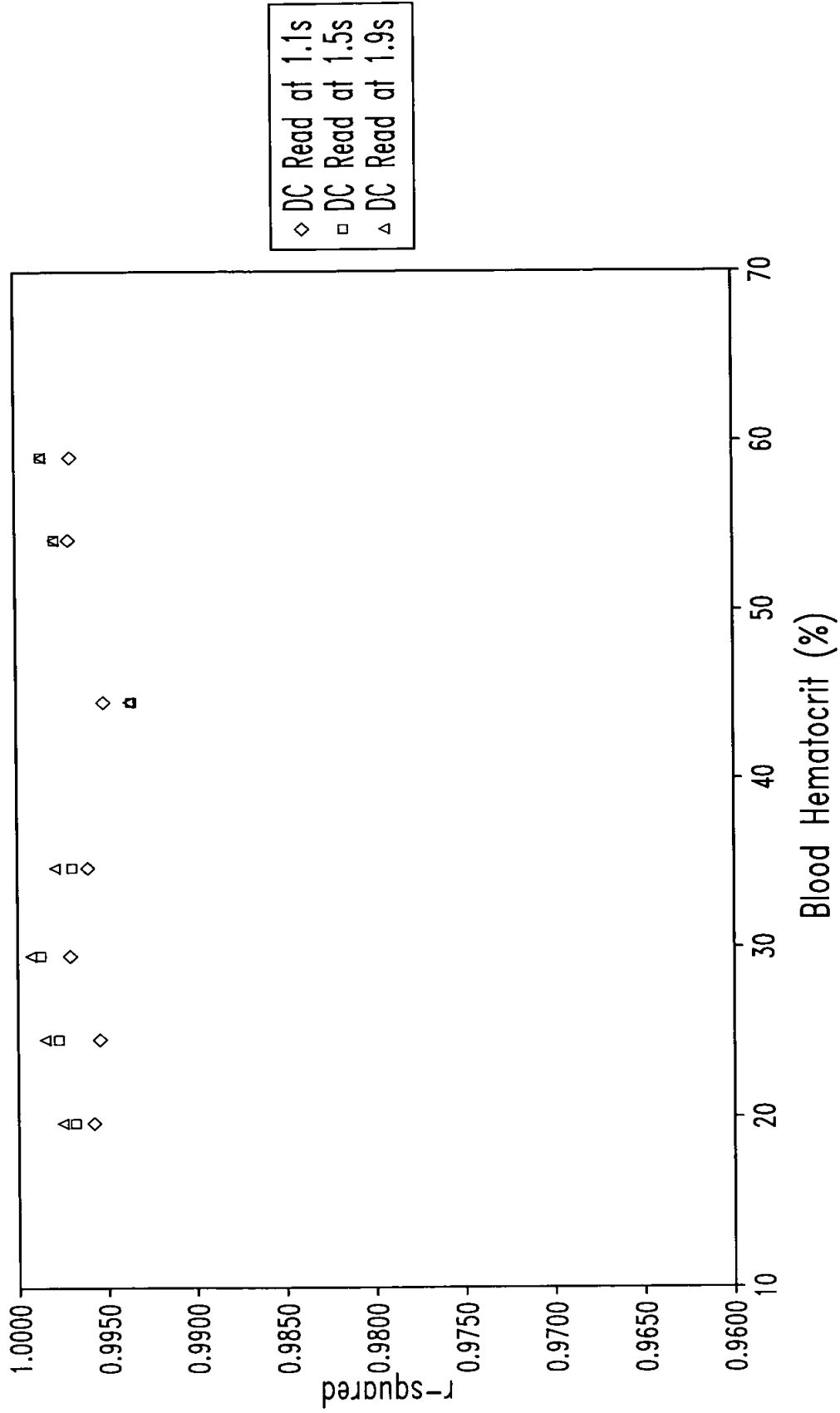

Fig. 25

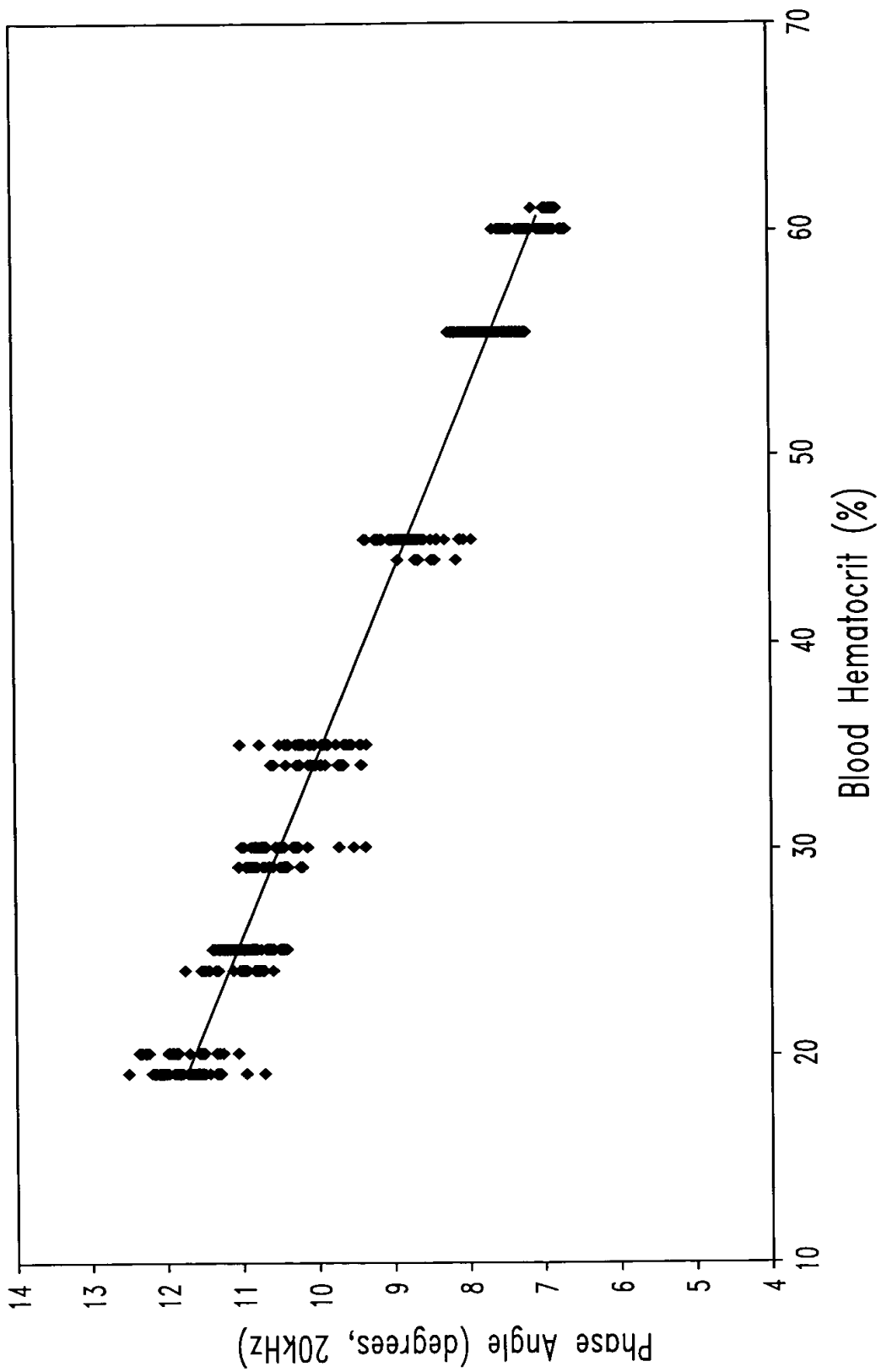

Fig. 26

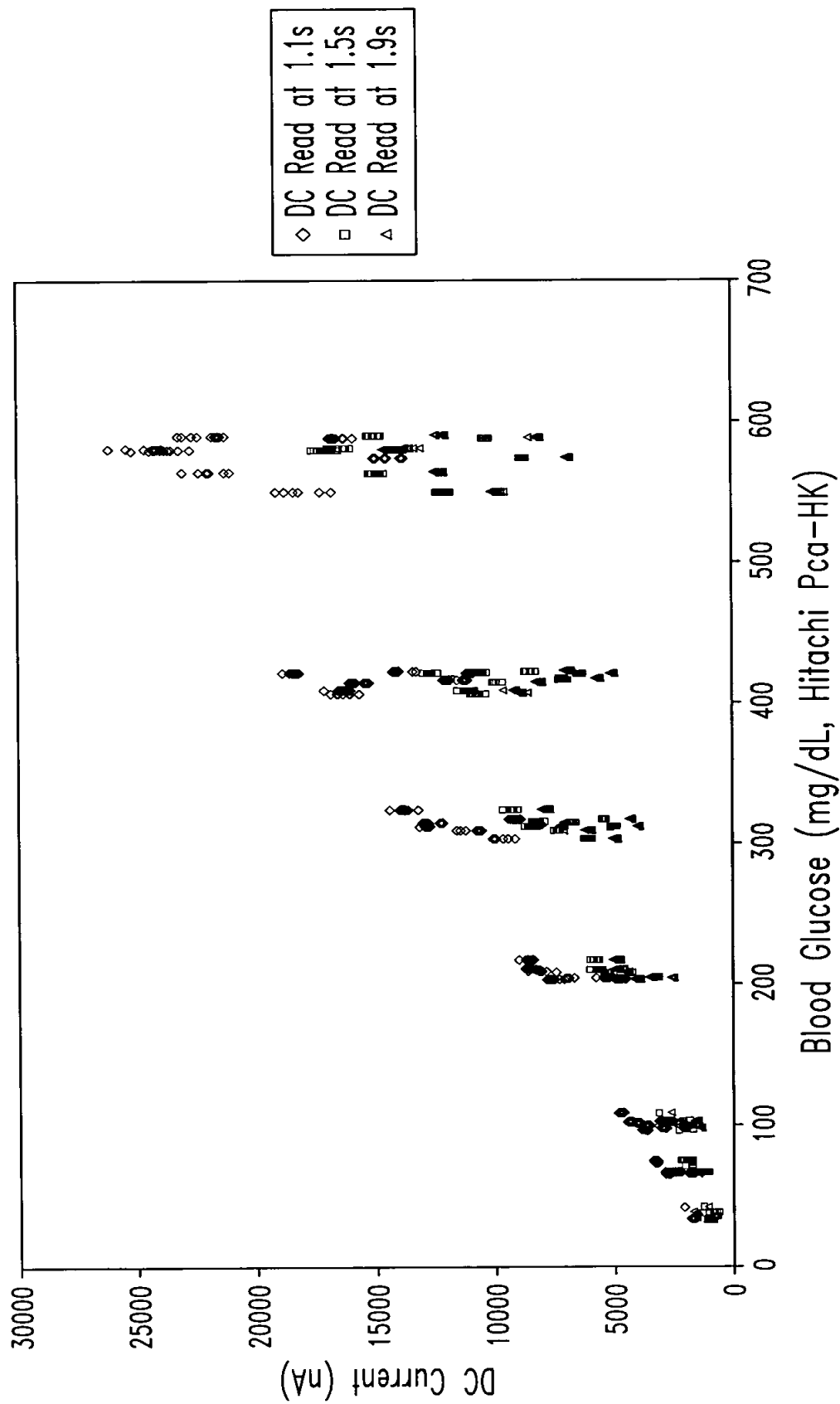

Fig. 27

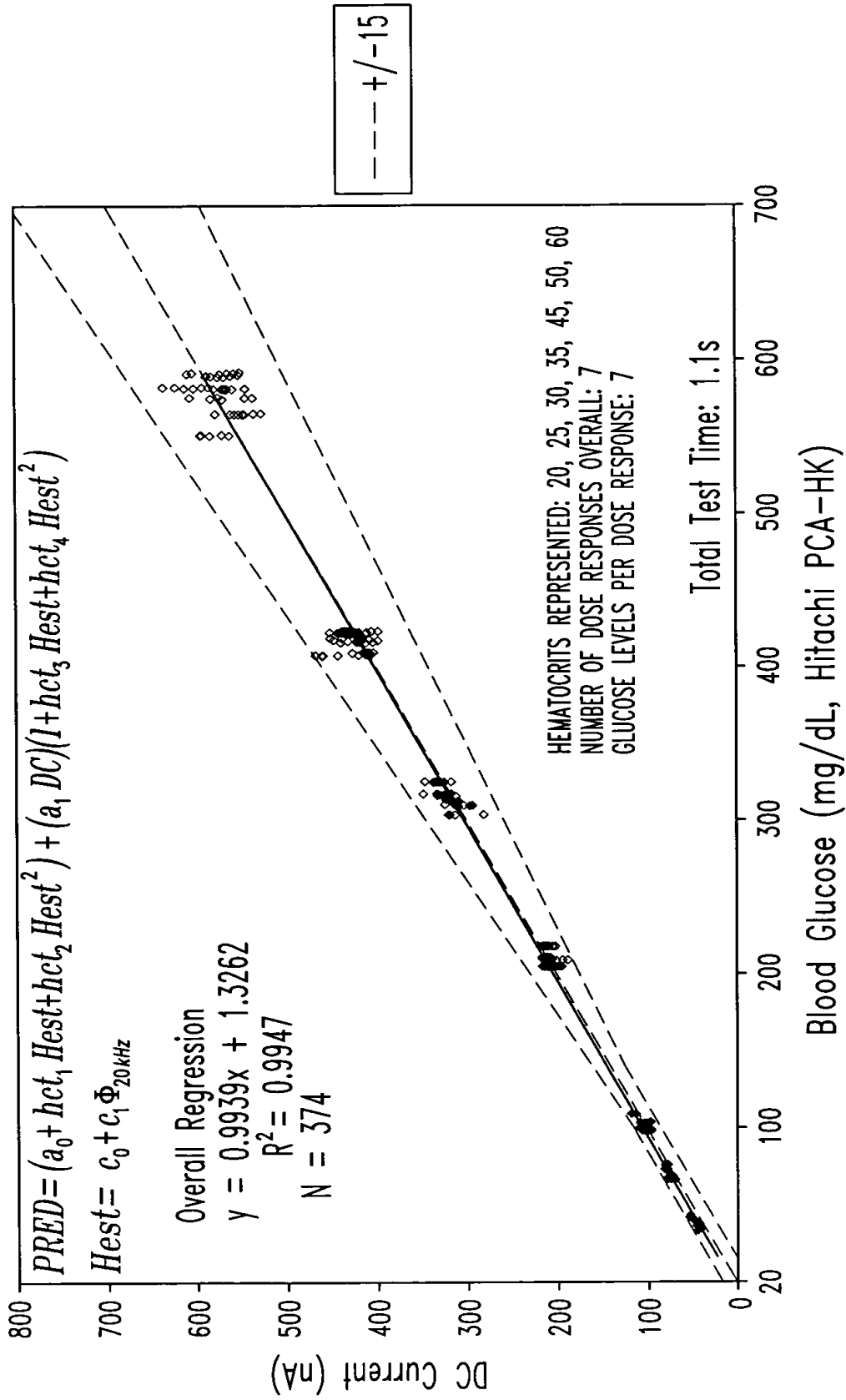

Fig. 28

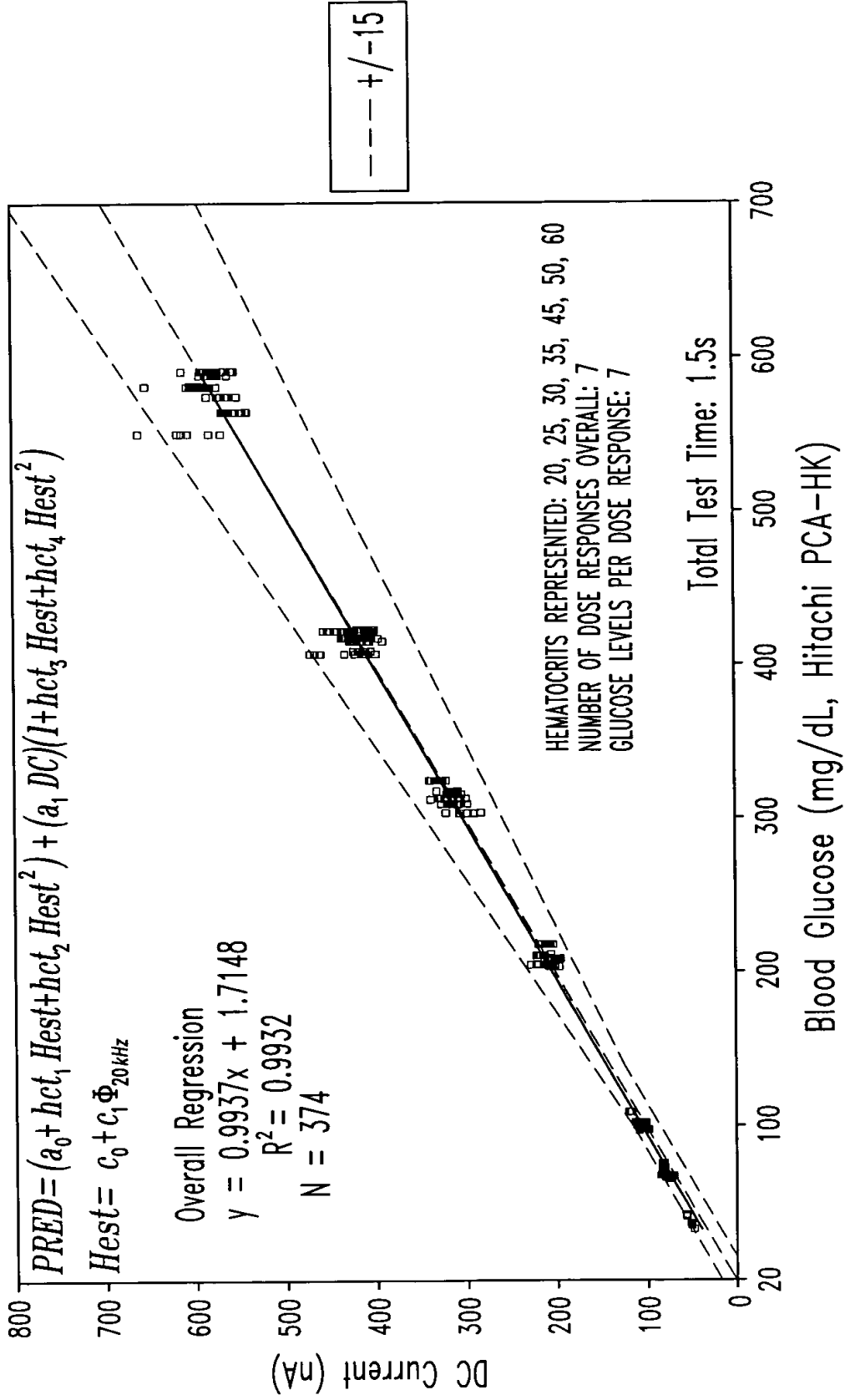

Fig. 29

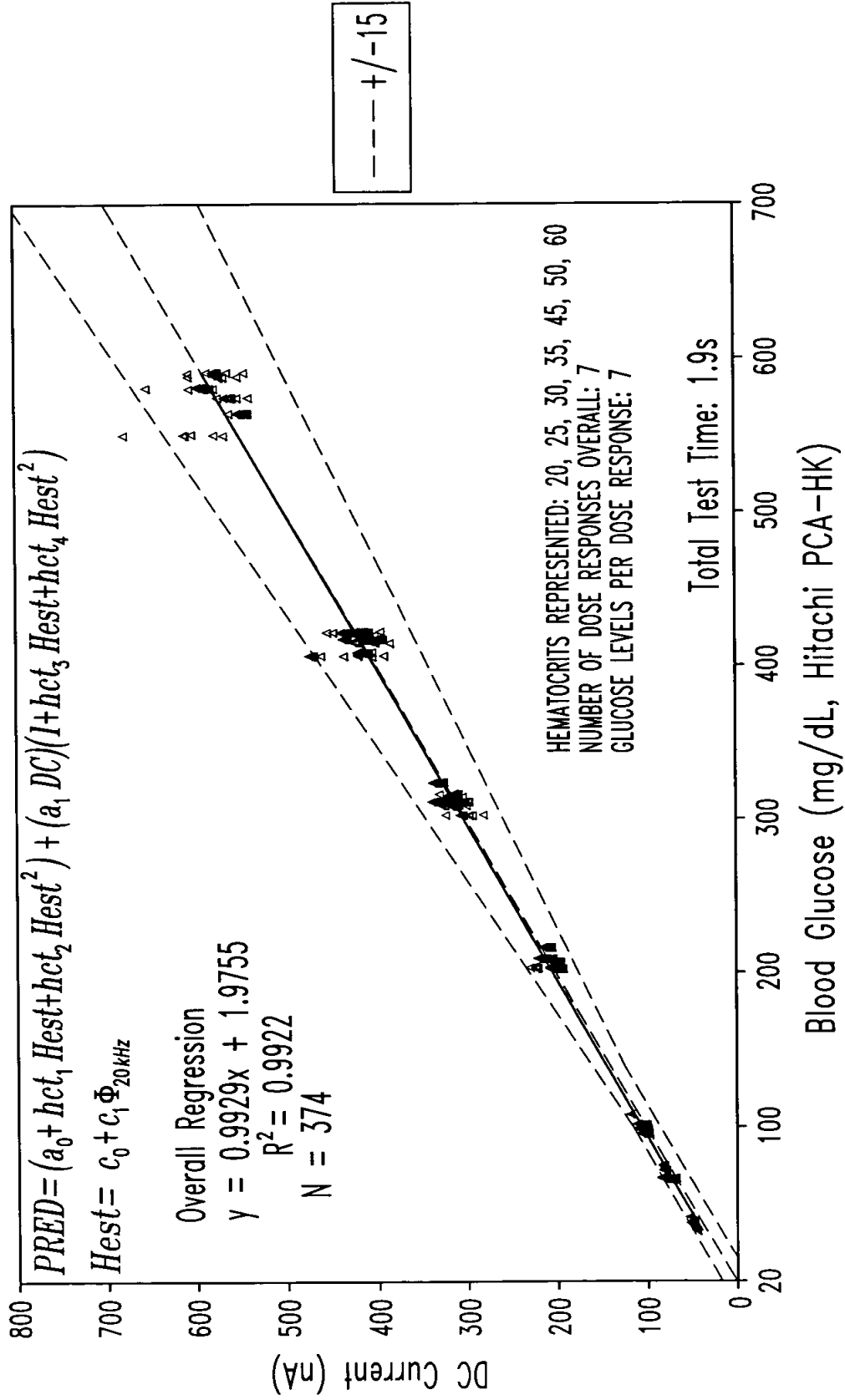

Fig. 30

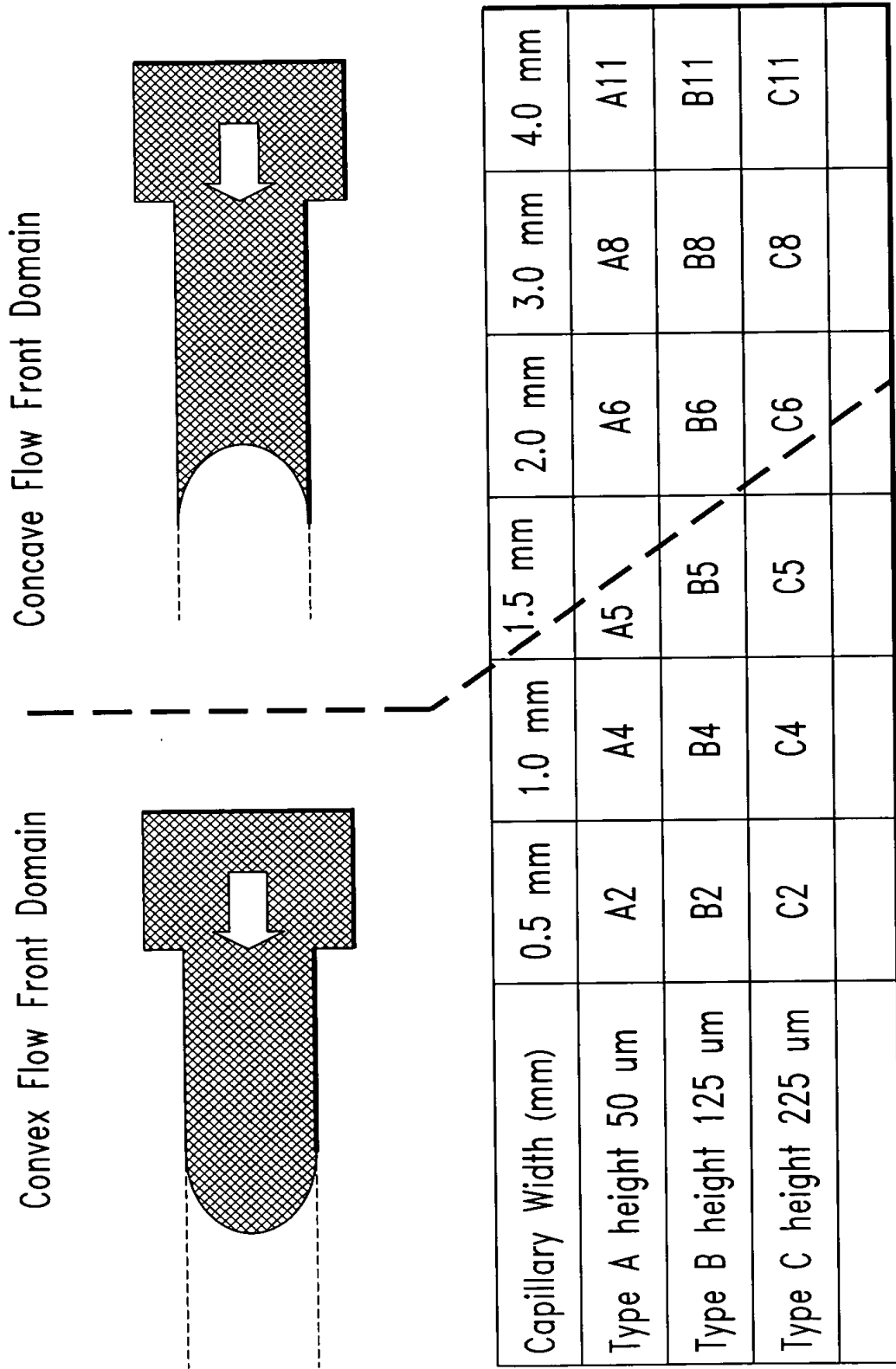

Fig. 31

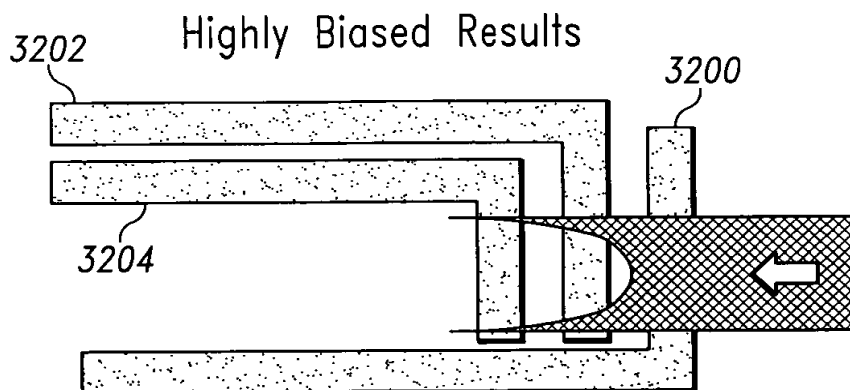

Fig. 32A

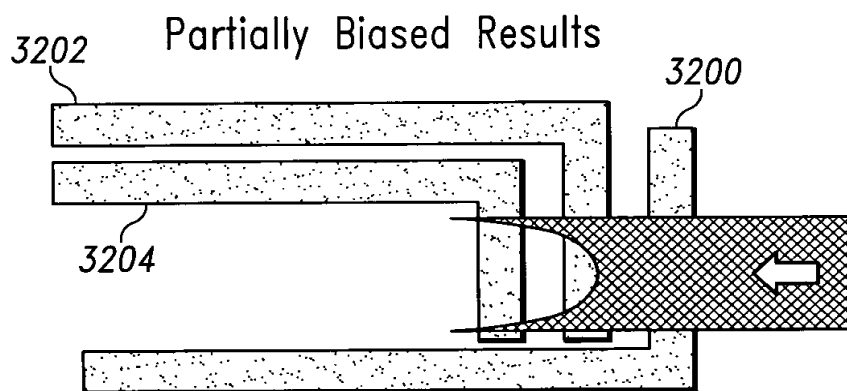

Fig. 32B

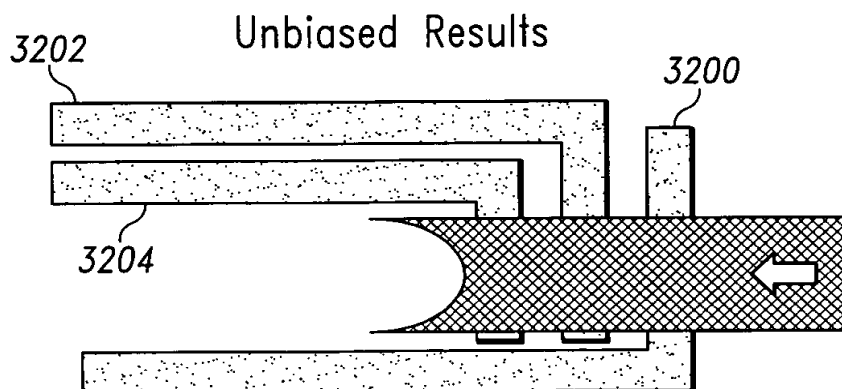

Fig. 32C

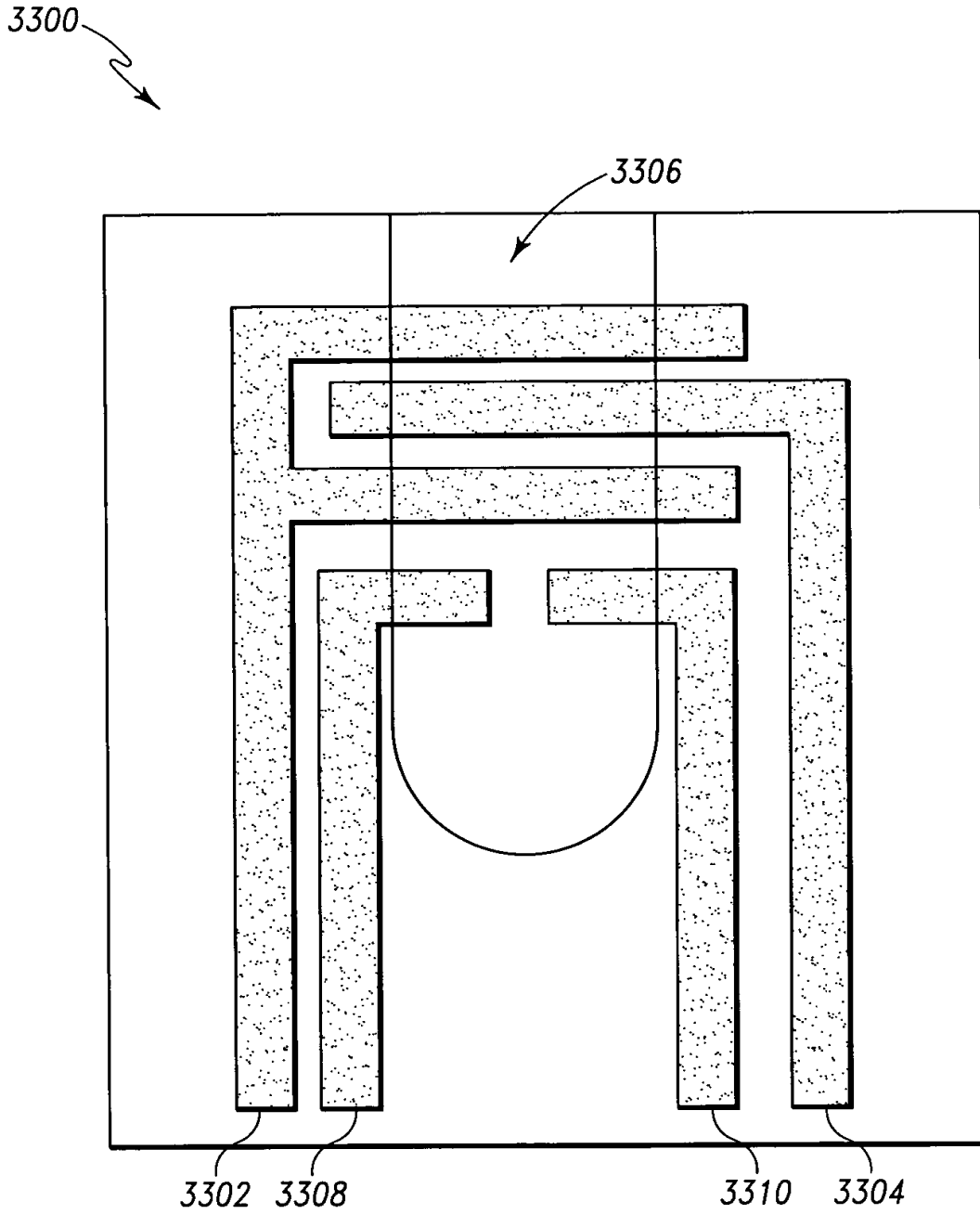

Fig. 33

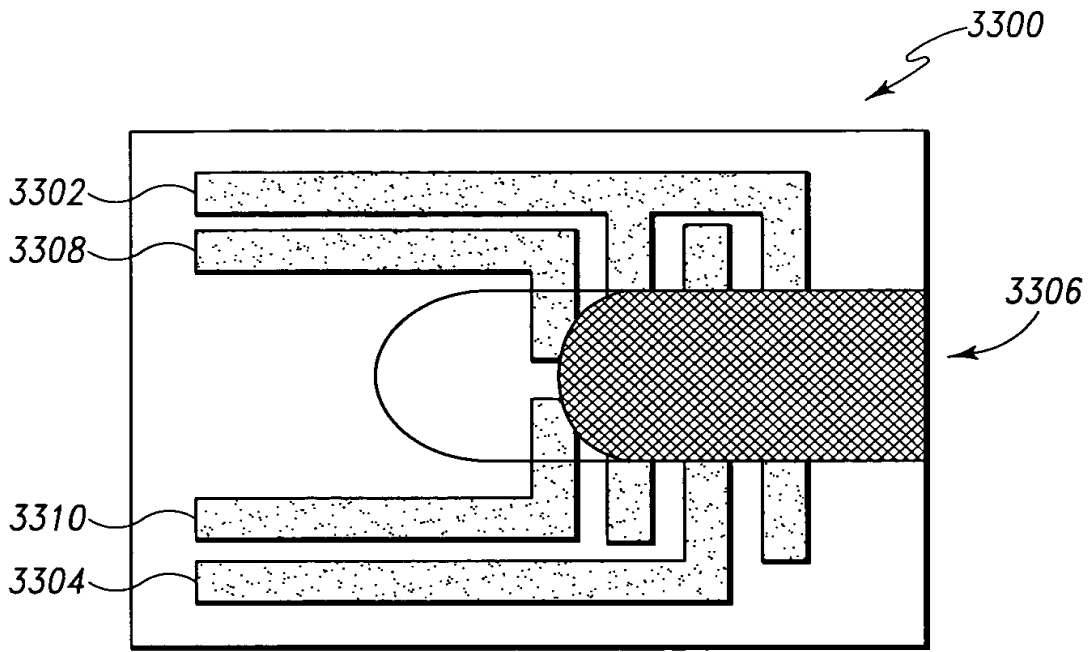

Fig. 34A

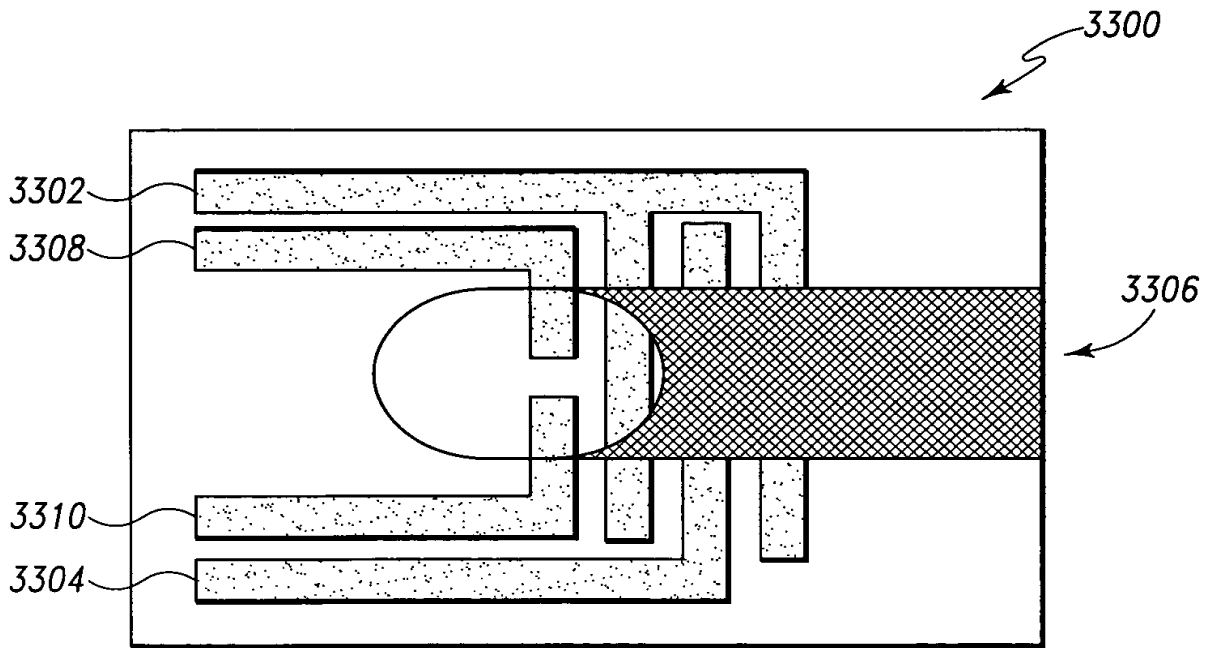

Fig. 34B

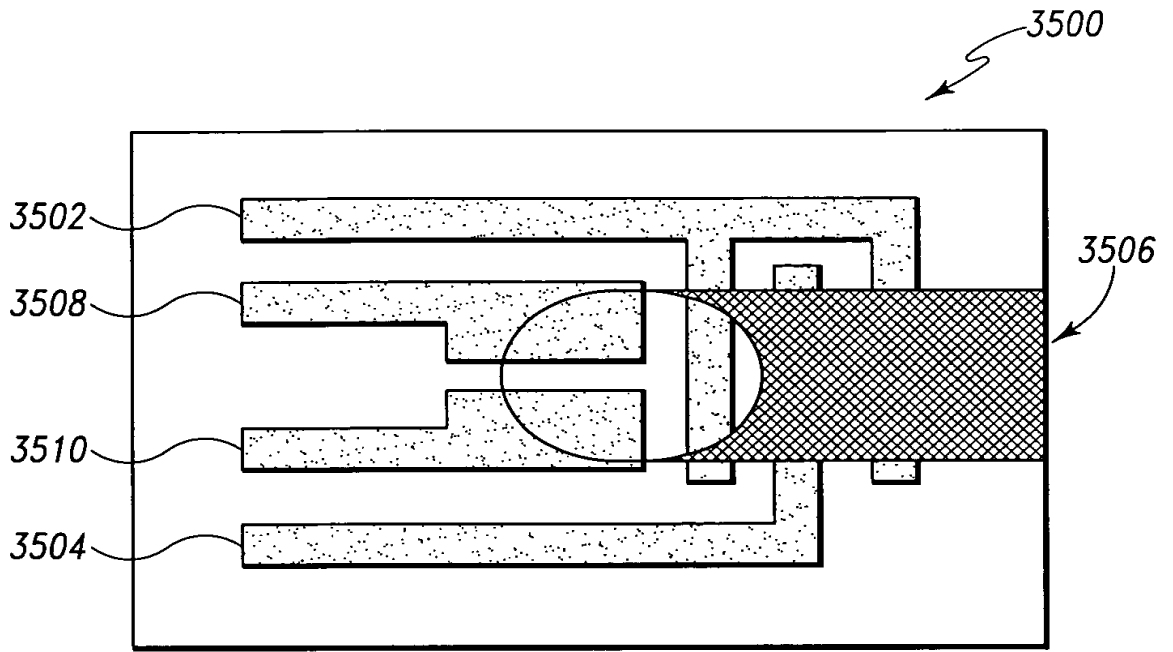

Fig. 35A

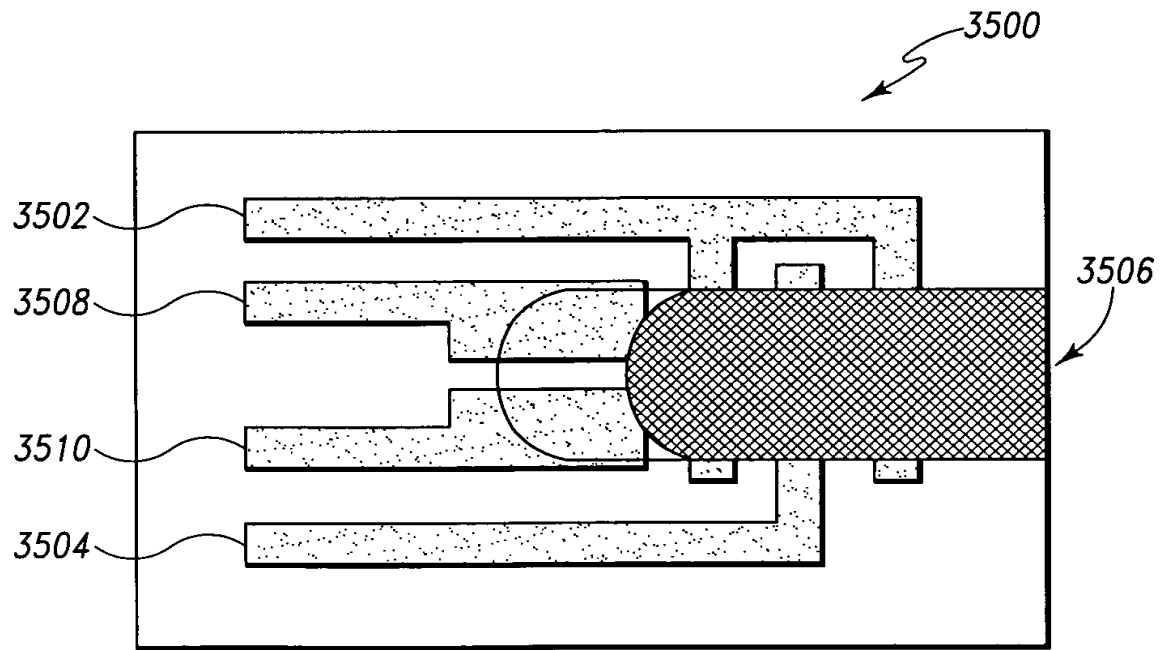

Fig. 35B

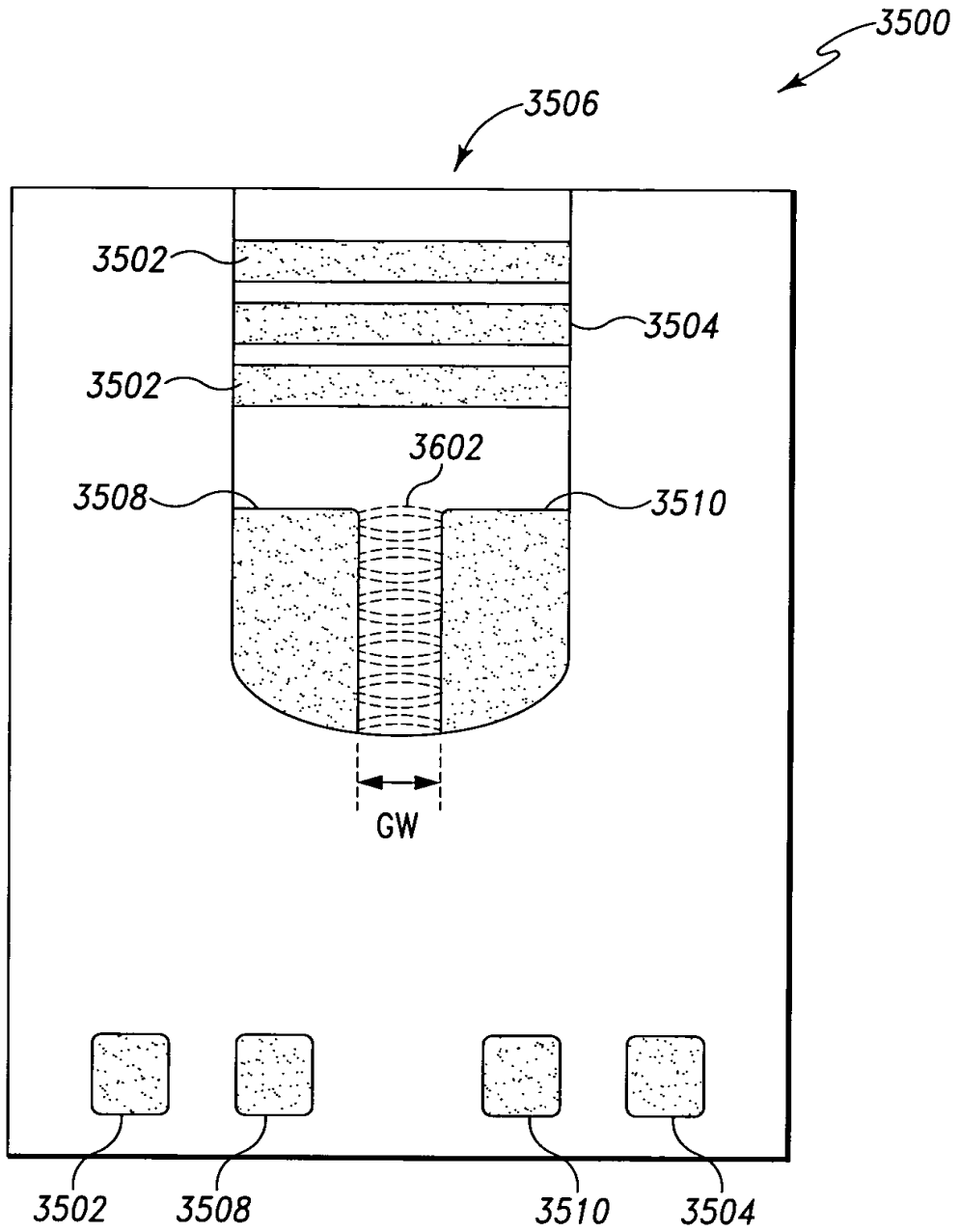

Fig. 36